

THIS DRAWING IS UNPUBLISHED. RELEASED FOR PUBLICATION APR 2011.
 © COPYRIGHT 2011 By Tyco Electronics Japan G.K. ALL RIGHTS RESERVED.

LOC		DIST		REVISIONS			
P	LTR	DESCRIPTION		DATE	DWN	APVD	
—	—	A	RELEASED	26JAN'15	J.W	S.L	

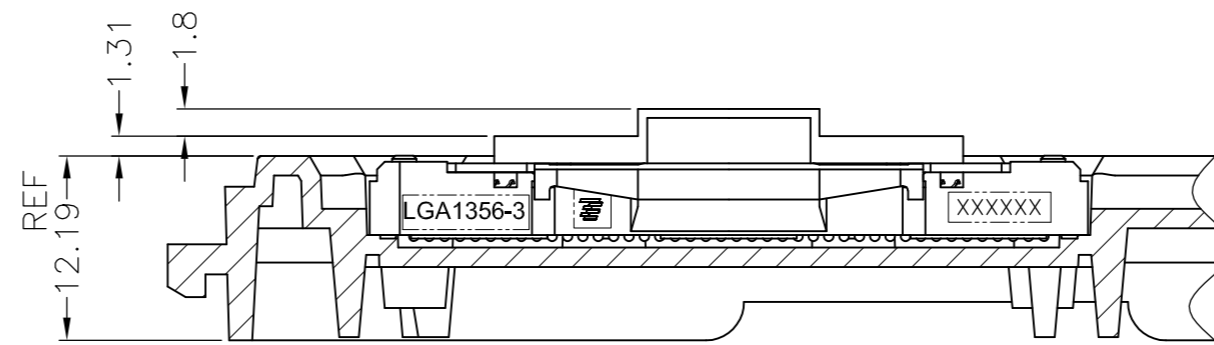
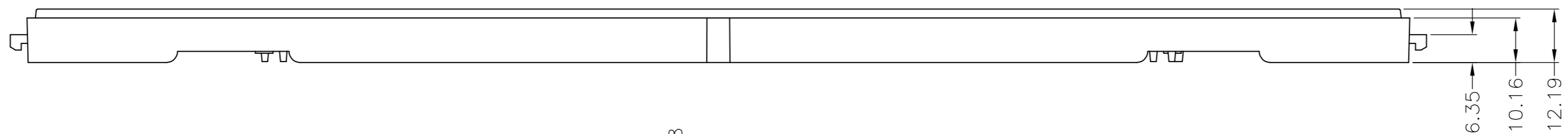
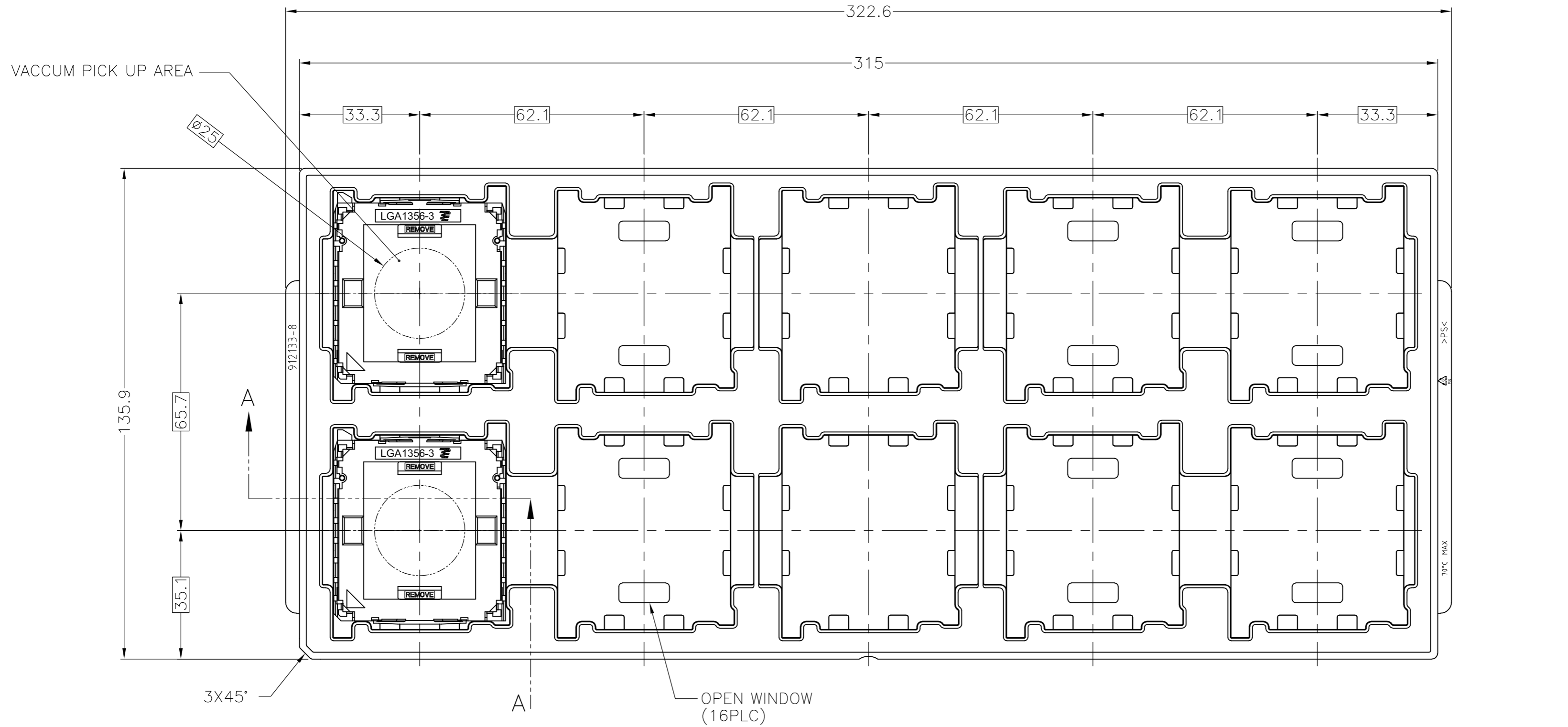

A-A (SCALE 2:1)
(SOCKET ASSY IS NOT SECTIONEND)

1. MATERIAL

- ① HOUSING : HIGH TEMP, THERMO-PLASTIC, UL94V-0, BLACK
 - ② CONTACT : COPPER ALLOY
FINISH : Au PL. AT CONTACT AREA ON OVERALL OVER Ni UNDER PL. 0.00127 MIN.
 - ③ SOLDER BALL : Sn/Ag/Cu FOR LEAD FREE PRODUCT
 - ④ CAP : HIGH TEMP. THERMO-PLASTIC, UL94V-0, BLACK
- △ INDICATED DATE CODE ON THE HSG

0.76 um MIN	2229732-2
0.38 um MIN	2229732-1
Au AT CONTACT AREA	PART NUMBER

THIS DRAWING IS A CONTROLLED DOCUMENT.		DWN	JEFF WANG	10SEP2014		TE Connectivity		
DIMENSIONS: mm		CHK	MURRAY LU	10SEP2014		NAME		
TOLERANCES UNLESS OTHERWISE SPECIFIED:		APVD	SIMON LI	10SEP2014		SOCKET ASSY		
0 PLC ± 1 PLC ± 2 PLC ±0.5 3 PLC ±3 4 PLC ± ANGLES ± FINISH -		PRODUCT SPEC	108-78496			LGA1356-3		
MATERIAL		APPLICATION SPEC	114-5432		SIZE	CAGE CODE	DRAWING NO	RESTRICTED TO
		WEIGHT	13.4 g		A2	00779	C=2229732	-
		CUSTOMER DRAWING		SCALE	1:1	SHEET	1 OF 4	REV
								A

2229732-1/-2 : AS SHOWN

THIS DRAWING IS UNPUBLISHED. RELEASED FOR PUBLICATION APR 2011.
 © COPYRIGHT 2011 By Tyco Electronics Japan G.K. ALL RIGHTS RESERVED.

LOC		DIST		REVISIONS			
P	LTR	DESCRIPTION	DATE	DWN	APVD		
-	-	-	-	-	-	-	-

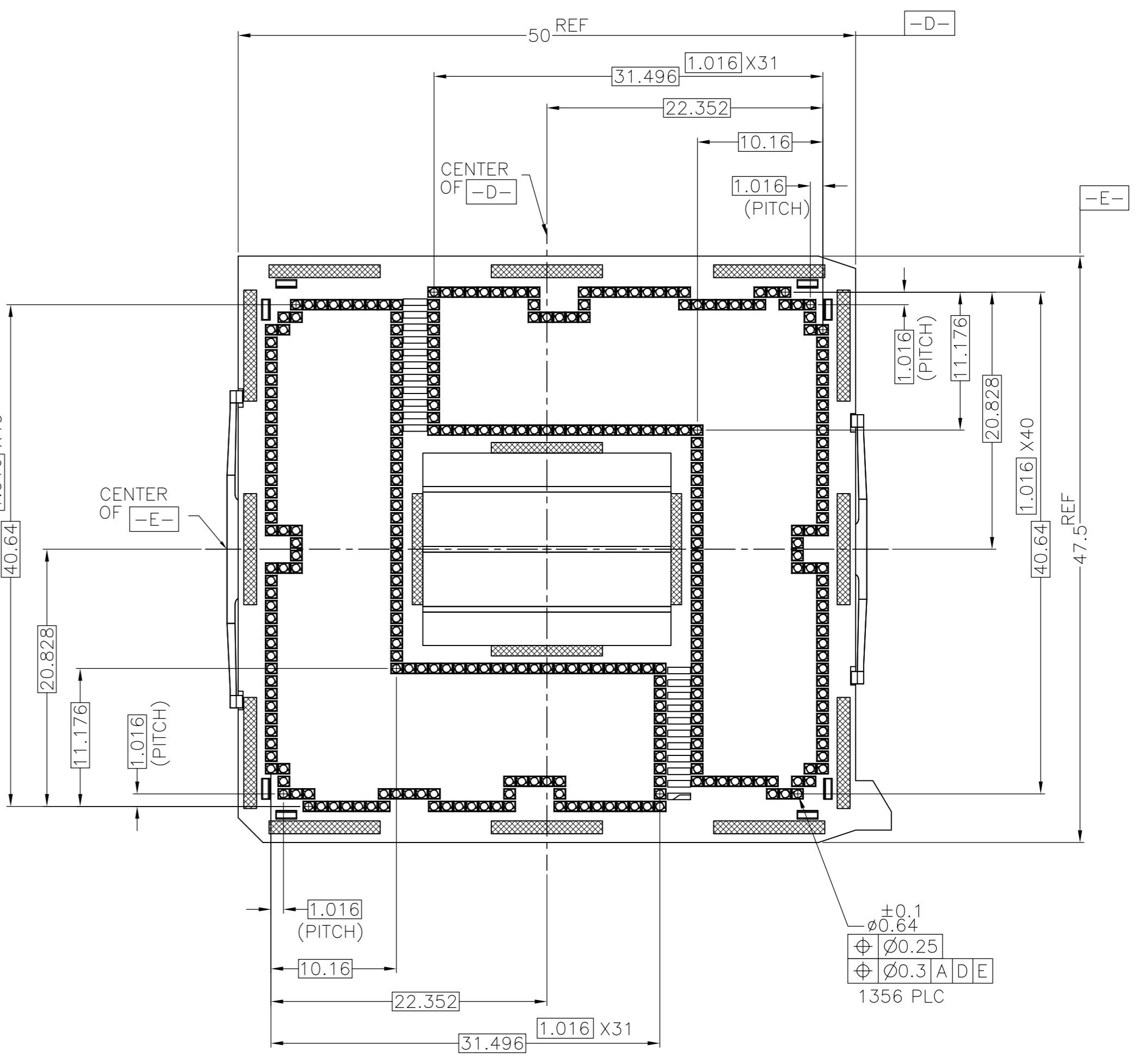
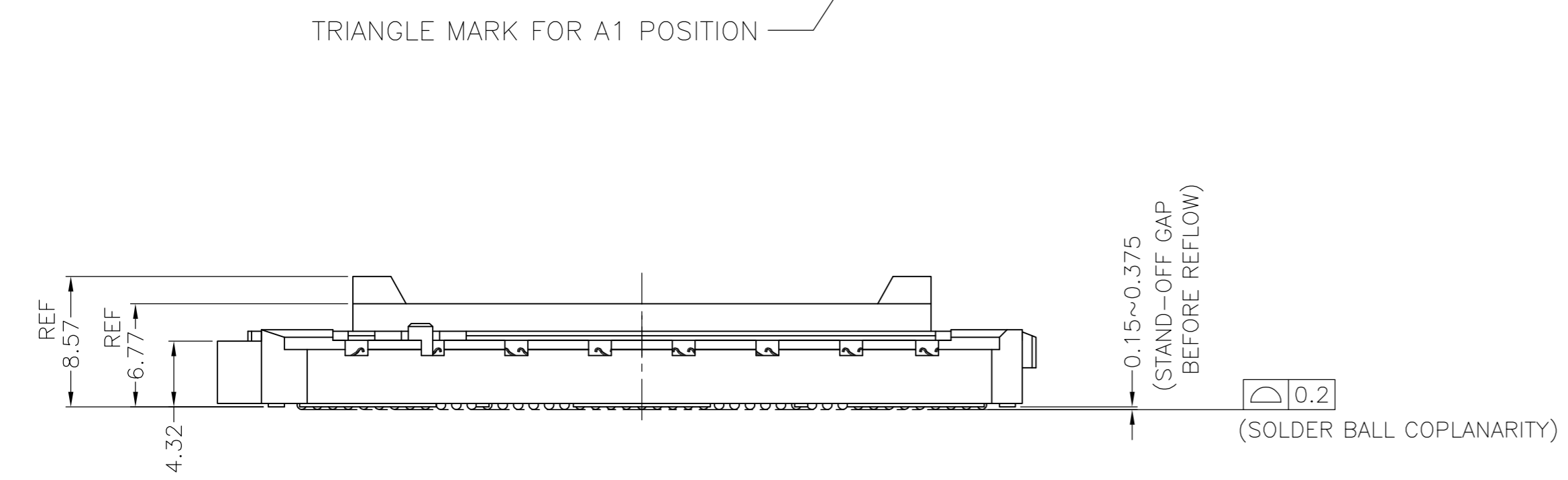
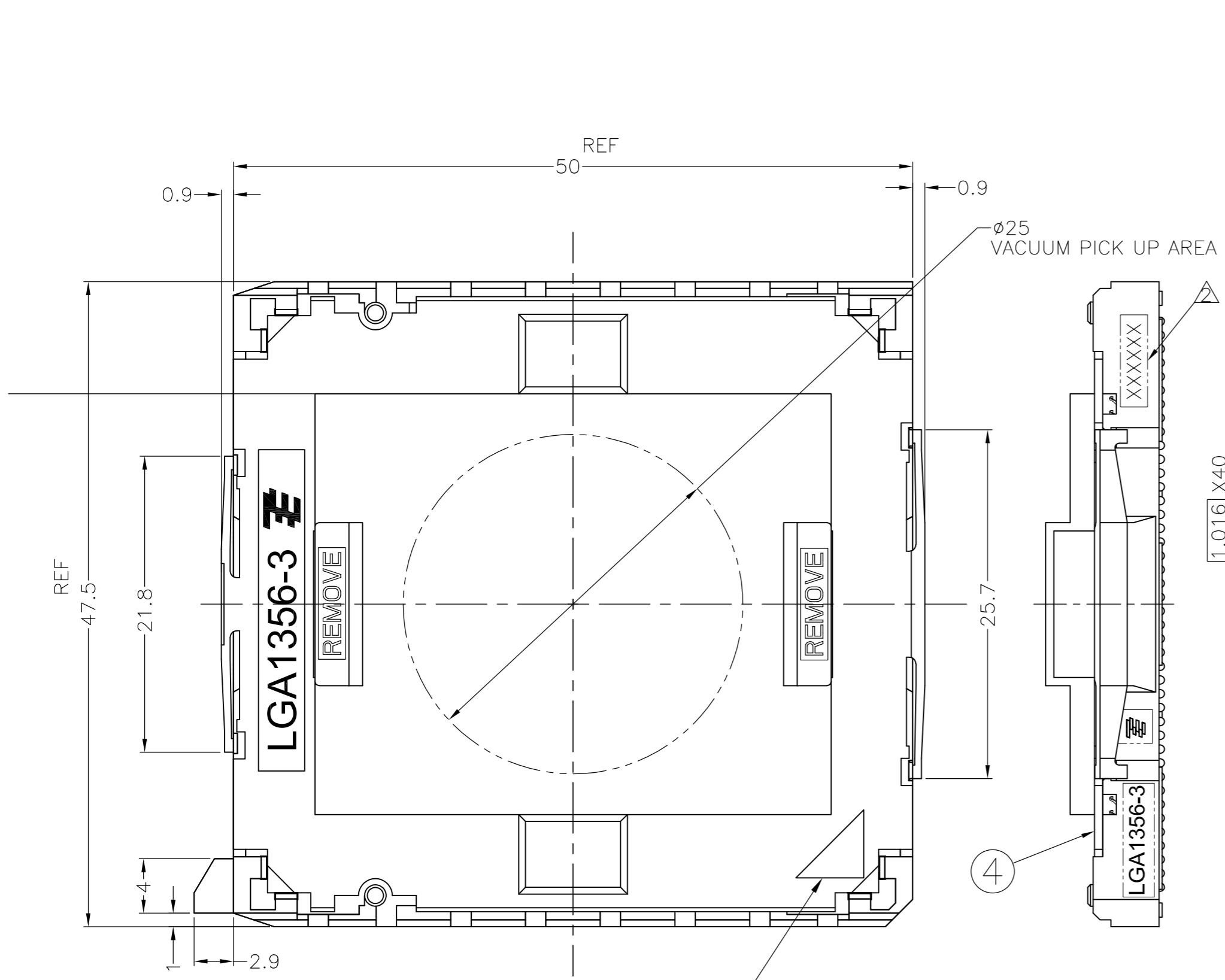

2229732-1/-2 : AS SHOWN

THIS DRAWING IS A CONTROLLED DOCUMENT.		DWN	TE TE Connectivity	
DIMENSIONS: mm		CHK		
TOLERANCES UNLESS OTHERWISE SPECIFIED:		APVD	NAME	
0 PLC ± 0.3		PRODUCT SPEC	SOCKET ASSY	
1 PLC ± 0.3		APPLICATION SPEC	LGA1356-3	
2 PLC ± 0.3		WEIGHT	SIZE	CAGE CODE
3 PLC ± 0.3		CUSTOMER DRAWING	A2	00779
4 PLC ± 0.3			DRAWING NO	RESTRICTED TO
ANGLES ± 3°			C=2229732	-
FINISH			SCALE	SHEET
			NTS	2 of 4
			REV	A

LOC		DIST		REVISIONS			
P	LTR	DESCRIPTION	DATE	DWN	APVD		
-	-	-	-	-	-	-	-

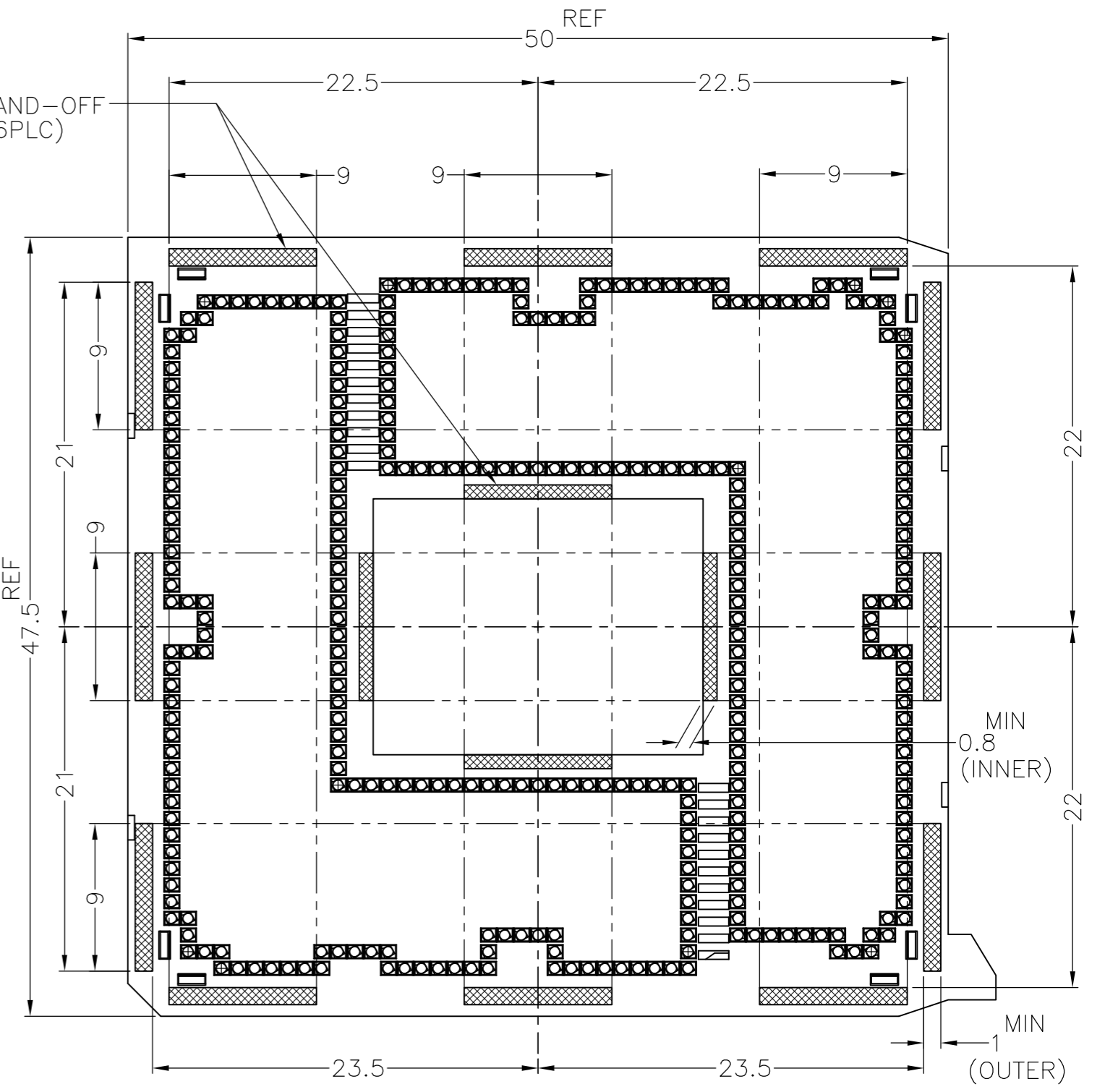
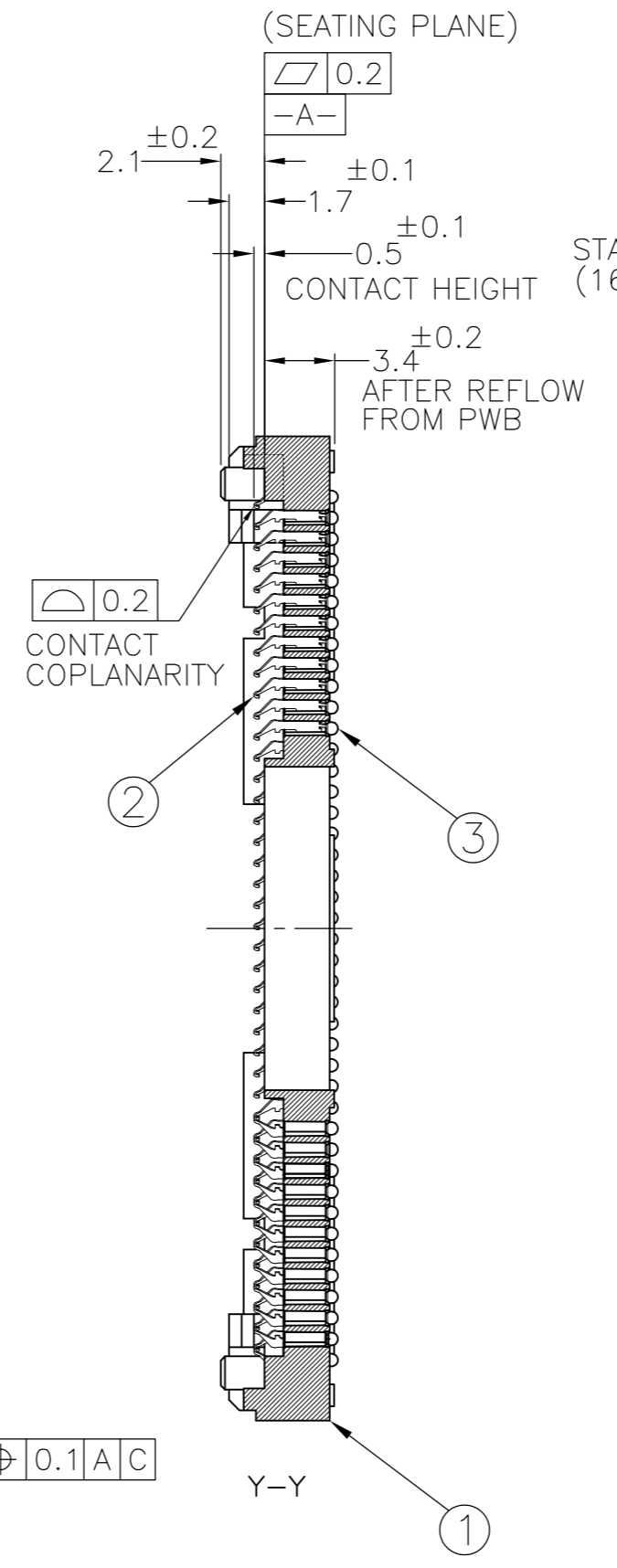
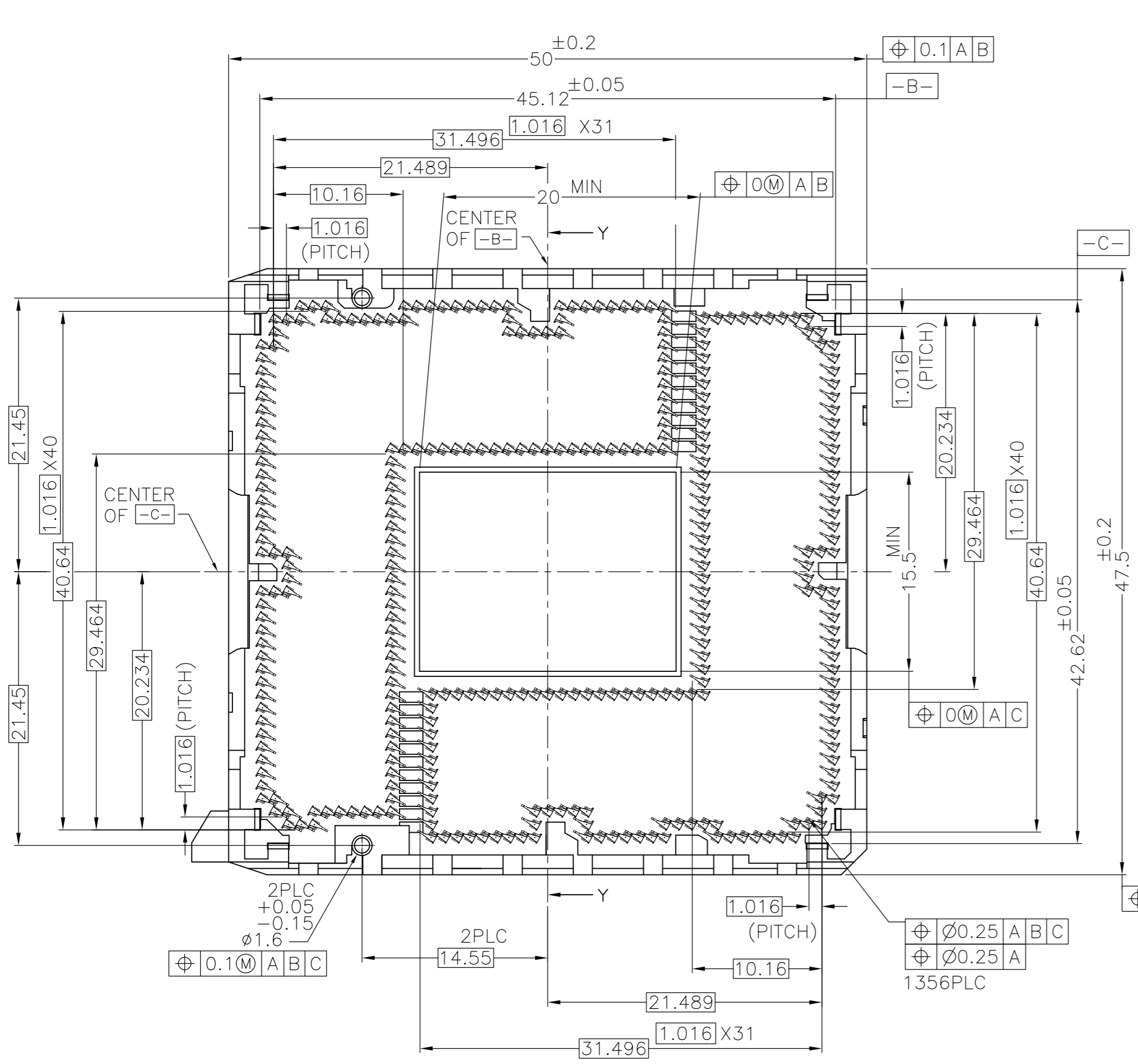

THESE VIEWS DON'T SHOW CAP

2229732-1/-2 : AS SHOWN

THIS DRAWING IS A CONTROLLED DOCUMENT.		DWN	TE Connectivity	
DIMENSIONS: mm		CHK	NAME	
TOLERANCES UNLESS OTHERWISE SPECIFIED:		APVD	SOCKET ASSY LGA1356-3	
0 PLC ± 0.3		PRODUCT SPEC	SIZE	CAGE CODE
1 PLC ± 0.3		APPLICATION SPEC	A2	00779
2 PLC ± 0.3		WEIGHT	DRAWING NO	RESTRICTED TO
3 PLC ± 0.3		CUSTOMER DRAWING	C=2229732	-
4 PLC ± 0.3		SCALE	NTS	SHEET 3 of 4
ANGLES ± 3°		REV	A	
FINISH				

THIS DRAWING IS UNPUBLISHED. RELEASED FOR PUBLICATION APR 2011.
 © COPYRIGHT 2011 By Tyco Electronics Japan G.K. ALL RIGHTS RESERVED.

LOC	DIST	REVISIONS			
P	LTR	DESCRIPTION	DATE	DWN	APVD
-	-	-	-	-	-

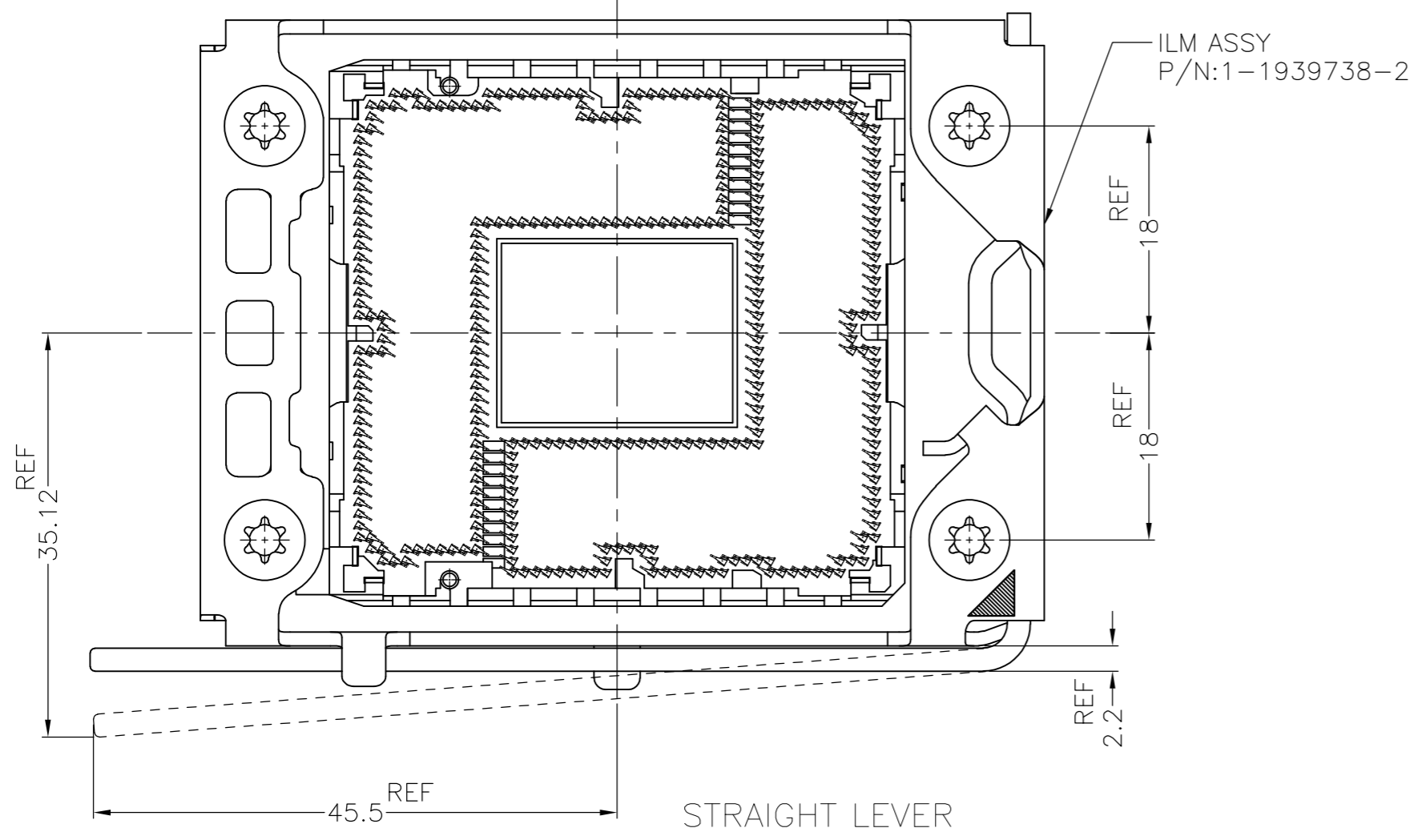
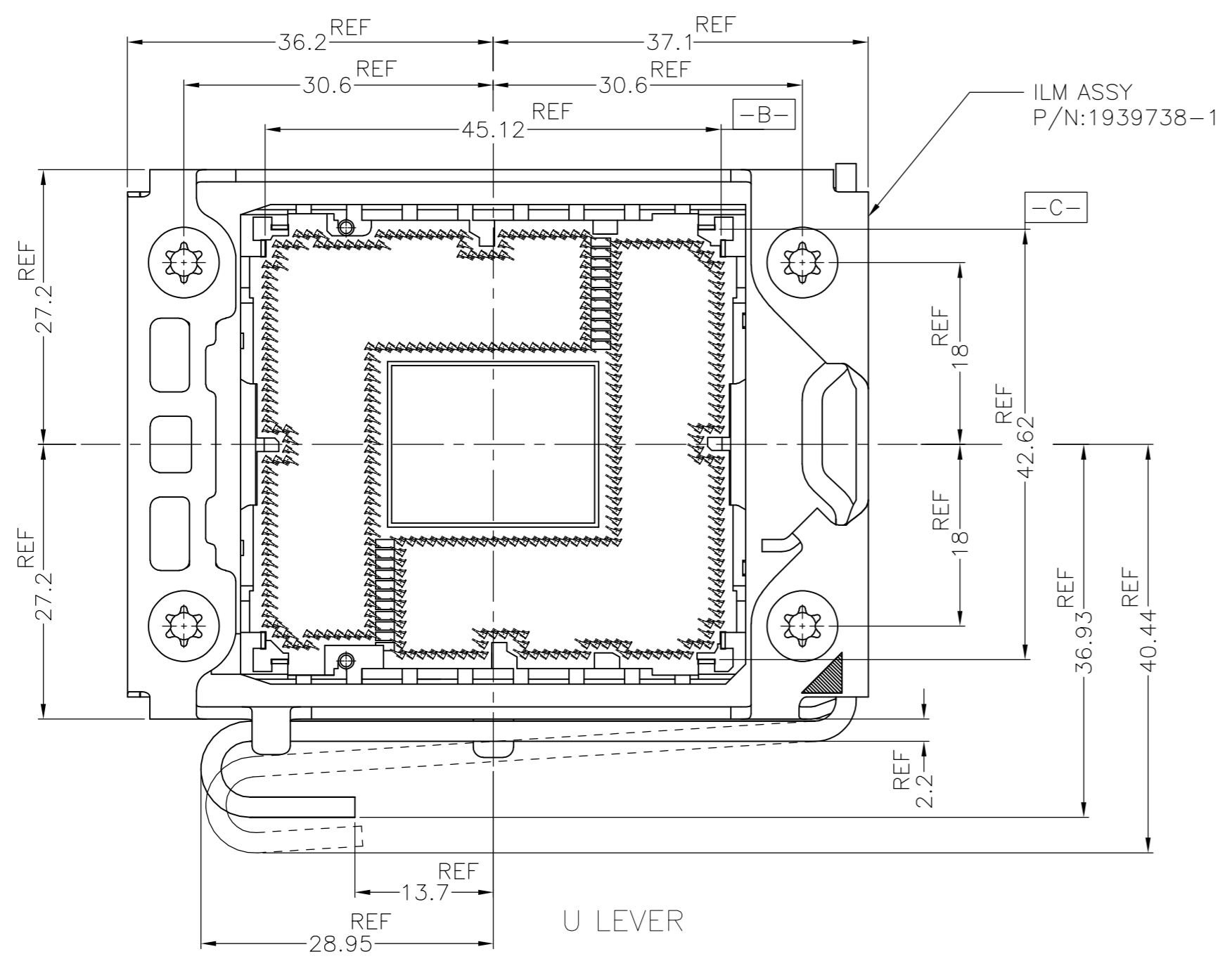

ILM ASSEMBLY OCCUPATION AREA (REFERENCE)
 CAP AND LOAD PLATE ARE NOT SHOWN ON THIS VIEW

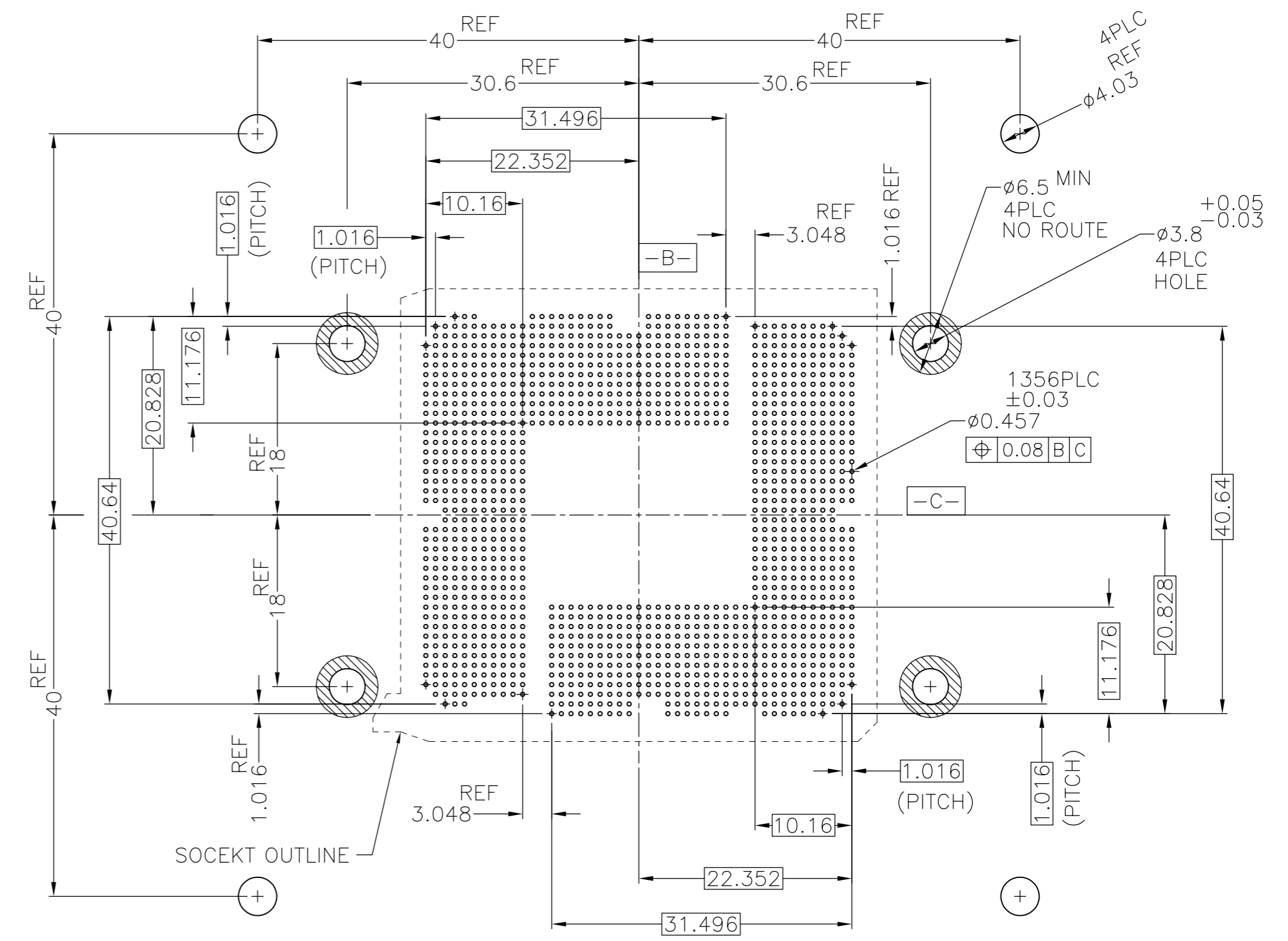

REFERENCE PATTERN LAYOUT

THIS DRAWING IS A CONTROLLED DOCUMENT.		DWN	TE Connectivity	
DIMENSIONS:	TOLERANCES UNLESS OTHERWISE SPECIFIED:	CHK	NAME	
mm	0 PLC ± 0.3 1 PLC ± 0.3 2 PLC ± 0.3 3 PLC ± 0.3 4 PLC ± 0.3 ANGLES ± 3°	APVD	SOCKET ASSY LGA1356-3	
MATERIAL	FINISH	PRODUCT SPEC	SIZE	CAGE CODE
		APPLICATION SPEC	A2	00779
		WEIGHT	DRAWING NO	RESTRICTED TO
			C=2229732	-
CUSTOMER DRAWING			SCALE	SHEET
			NTS	4 OF 4
			REV	A