

0-2112058-2  CAVITY 8 CLOSED	1-2112058-0  CAVITY 3, 7, 8 CLOSED	1-2112058-8  CAVITY 1, 2, 3, 4, 8 CLOSED	2-2112058-2 C7  CAVITY 1, 2, 4, 6, 7, 8 CLOSED
0-2112058-3  CAVITY 6 CLOSED	1-2112058-1  CAVITY 5, 7 CLOSED	1-2112058-9  CAVITY 1, 5, 6, 7, 8 CLOSED	
0-2112058-4  CAVITY 7, 8 CLOSED	1-2112058-2  CAVITY 5, 7, 8 CLOSED	2-2112058-0 C7  CAVITY 5 CLOSED	
0-2112058-5  CAVITY 1, 2 CLOSED	1-2112058-3  CAVITY 3, 5, 7, 8 CLOSED	2-2112058-1 C7  CAVITY 4 CLOSED	
0-2112058-6  CAVITY 7 CLOSED	1-2112058-4  CAVITY 2, 4 CLOSED		
0-2112058-7  CAVITY 3, 7 CLOSED	1-2112058-5  CAVITY 1, 2, 4 CLOSED		
0-2112058-8  CAVITY 2 CLOSED	1-2112058-6  CAVITY 1, 2, 4, 6 CLOSED		
0-2112058-9  CAVITY 4, 6 CLOSED	1-2112058-7  CAVITY 1, 2, 6 CLOSED		

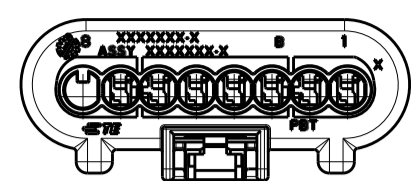

DESIGN OF VOID CORING AND POSITION OF DATE CLOCK IS OPTIONAL

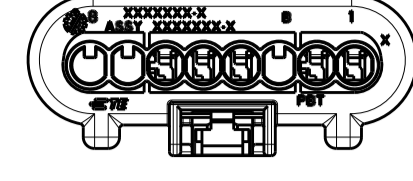
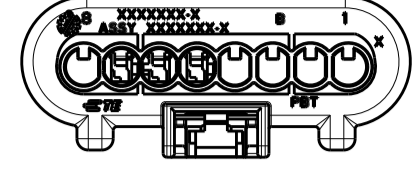
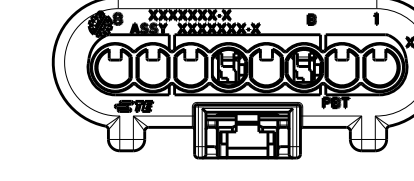
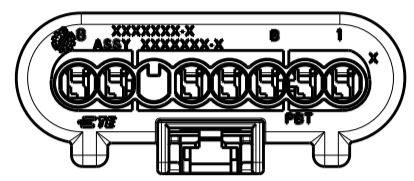
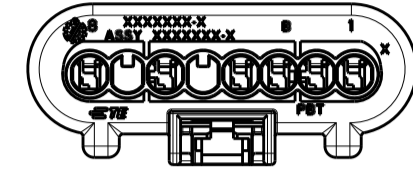
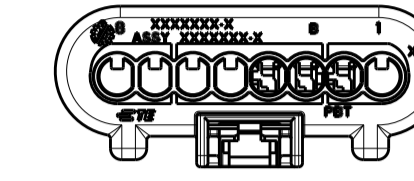
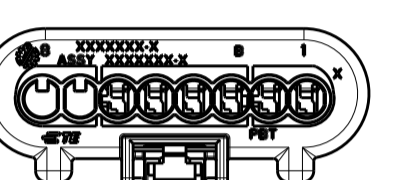
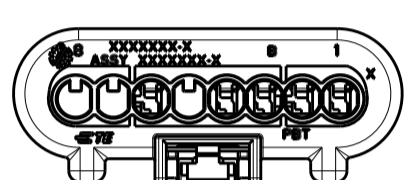
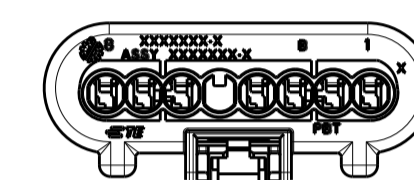
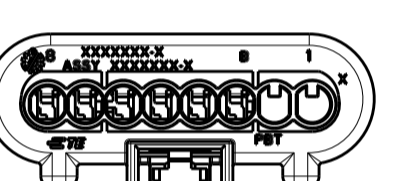
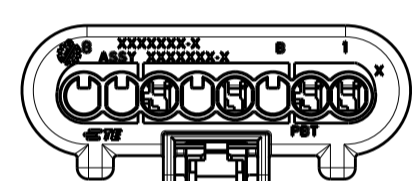
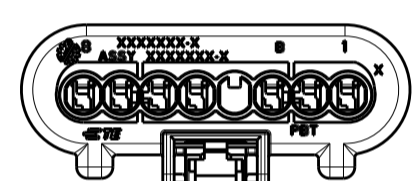
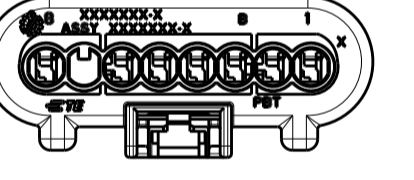
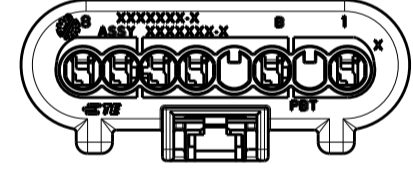
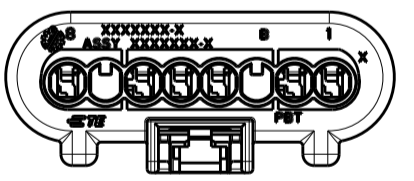
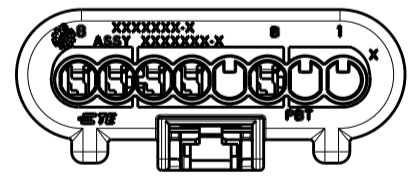
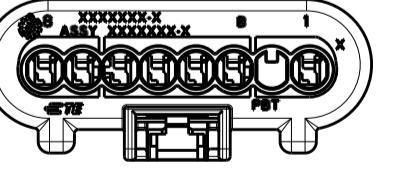
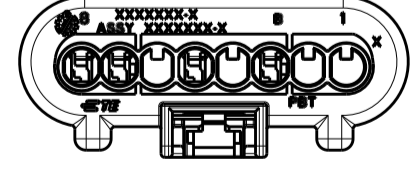
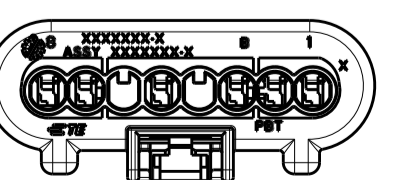
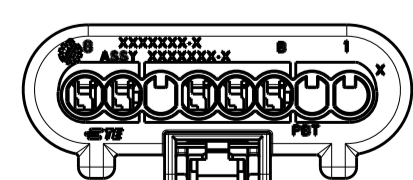
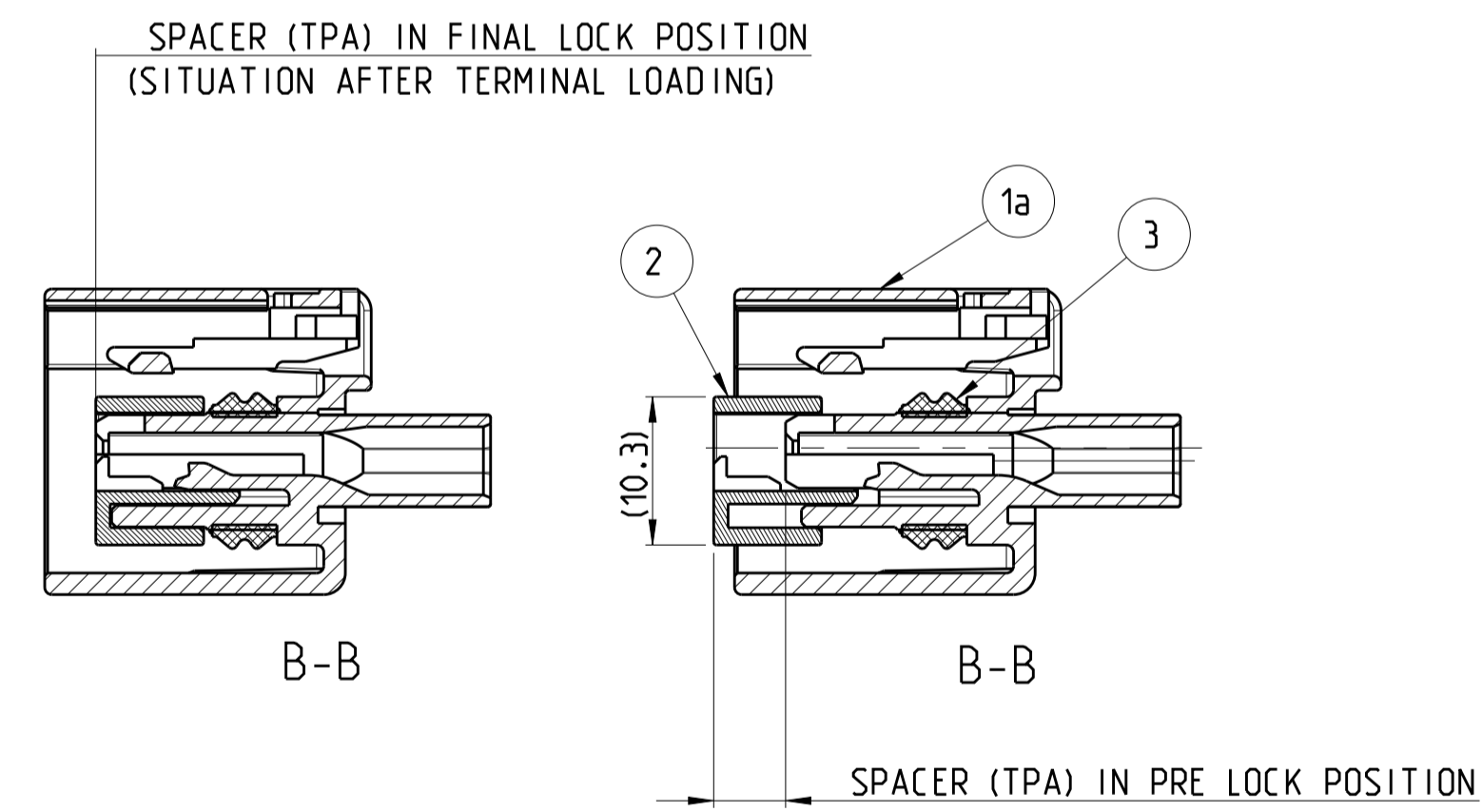
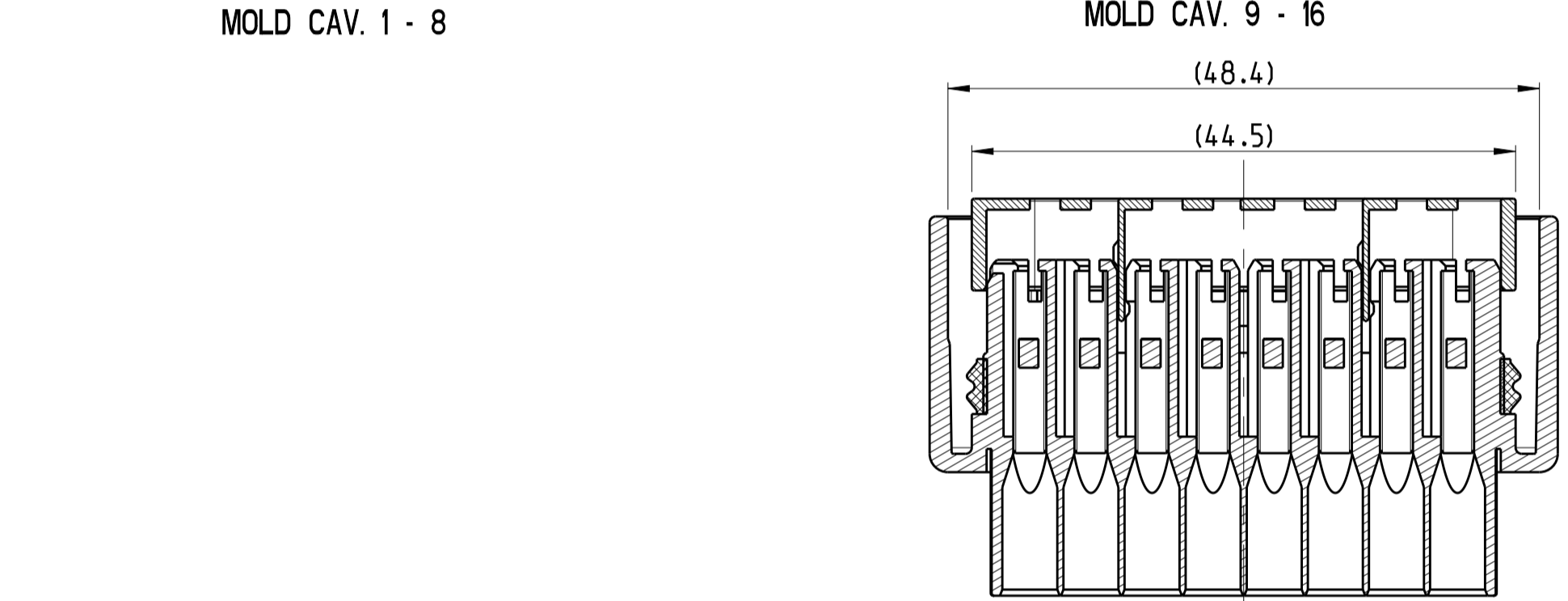
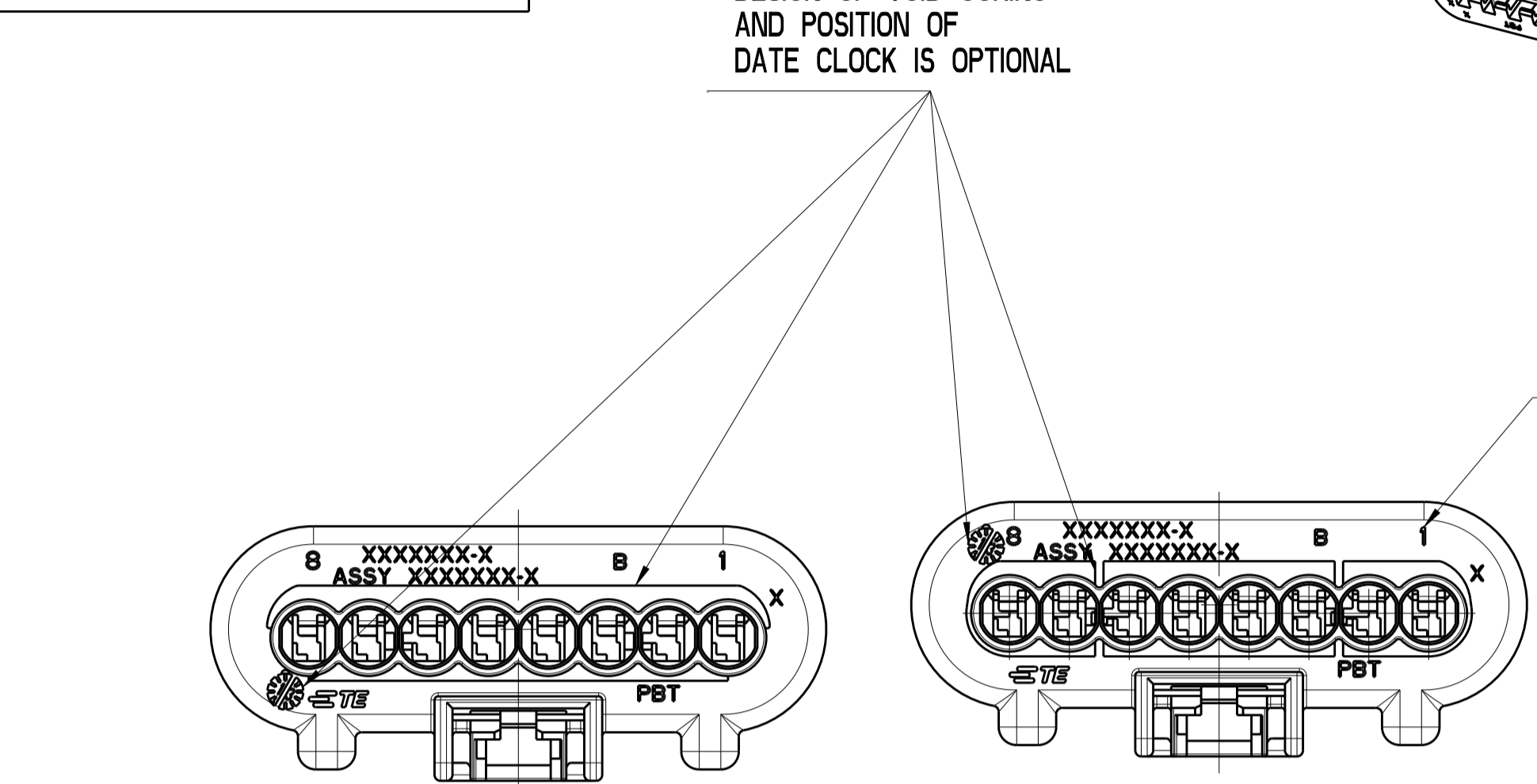
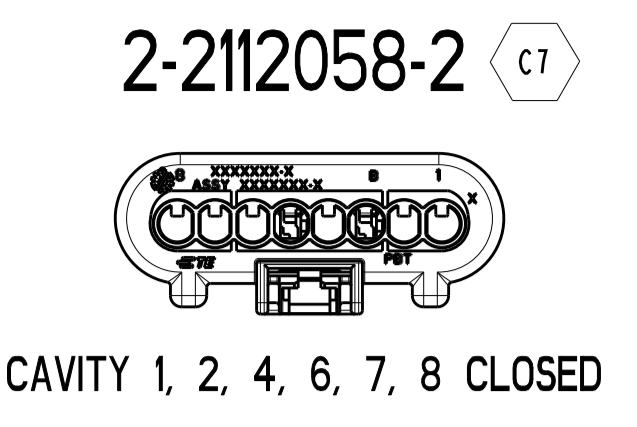
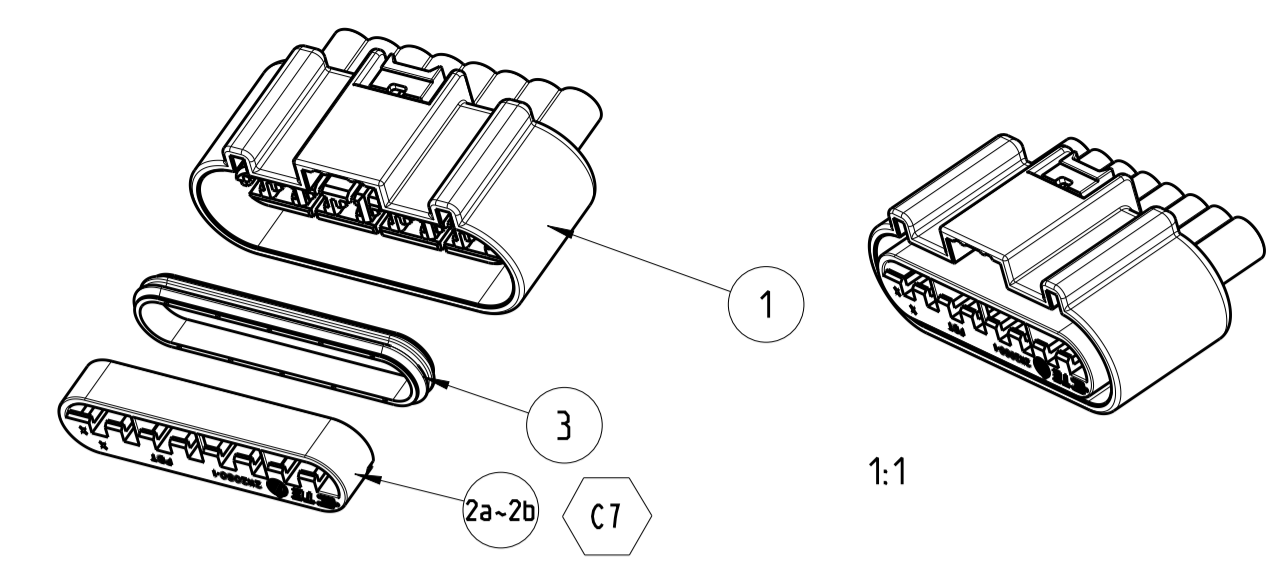

LOC	DIST	REV	DESCRIPTION	DATE	DMN	APVD
A1	-	C4	E-13-012477	06AUG2013	MT	HR
		C5	E-15-006021	16APR2015	MT	HR
		C6	E-16-007905	03JUN2016	MT	HR
		C7	E-17-005893	27APR2017	D.D	I.Y

- NOTES:
- 1.5MM FEMALE TERMINAL SEALED SUITABLE TERMINALS: SINGLE WIRE SEALS FORD CAT. 2 (SUPPLIER YAZAKI)
 - PACKAGING: TRAYS IN CARDBOARD BOX
 - PIN NUMBERING ON CABLE EXIT SIDE
 - USED INTERFACE SEE SPEC. 114-18999

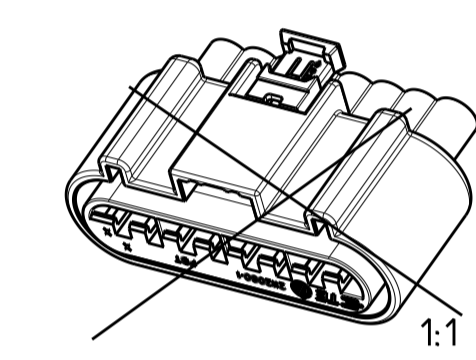

CPA	PBT-GF10	RED	4
PERIPHERAL SEAL	SILICON	LIGHT BLUE	3
SPACER	PBT	RED	2
FEMALE HOUSING	PBT	BLACK	1a

ASSY NO	CODE	REV	MATERIAL	COLOR	ITEM NO	
2-2112058-2	A	C	PERIPHERAL SEAL	SILICON	LIGHT BLUE	3
			SPACER	PBT	LIGHT GRAY	2D
			FEMALE HOUSING	PBT	BLACK	1
2-2112058-1	A	C	PERIPHERAL SEAL	SILICON	LIGHT BLUE	3
			SPACER	PBT	RED	2a
			FEMALE HOUSING	PBT	BLACK	1
2-2112058-0	A	C	PERIPHERAL SEAL	SILICON	LIGHT BLUE	3
			SPACER	PBT	RED	2a
			FEMALE HOUSING	PBT	BLACK	1
1-2112058-9	A	C	PERIPHERAL SEAL	SILICON	LIGHT BLUE	3
			SPACER	PBT	LIGHT GRAY	2D
			FEMALE HOUSING	PBT	BLACK	1
1-2112058-8	A	C	PERIPHERAL SEAL	SILICON	LIGHT BLUE	3
			SPACER	PBT	LIGHT GRAY	2D
			FEMALE HOUSING	PBT	BLACK	1
1-2112058-7	A	C	PERIPHERAL SEAL	SILICON	LIGHT BLUE	3
			SPACER	PBT	RED	2a
			FEMALE HOUSING	PBT	BLACK	1
1-2112058-6	A	C	PERIPHERAL SEAL	SILICON	LIGHT BLUE	3
			SPACER	PBT	RED	2a
			FEMALE HOUSING	PBT	BLACK	1
1-2112058-5	A	C	PERIPHERAL SEAL	SILICON	LIGHT BLUE	3
			SPACER	PBT	RED	2a
			FEMALE HOUSING	PBT	BLACK	1
1-2112058-4	A	C	PERIPHERAL SEAL	SILICON	LIGHT BLUE	3
			SPACER	PBT	RED	2a
			FEMALE HOUSING	PBT	BLACK	1
1-2112058-3	A	C	PERIPHERAL SEAL	SILICON	LIGHT BLUE	3
			SPACER	PBT	RED	2a
			FEMALE HOUSING	PBT	BLACK	1
1-2112058-2	A	C	PERIPHERAL SEAL	SILICON	LIGHT BLUE	3
			SPACER	PBT	RED	2a
			FEMALE HOUSING	PBT	BLACK	1
1-2112058-1	A	C	PERIPHERAL SEAL	SILICON	LIGHT BLUE	3
			SPACER	PBT	RED	2a
			FEMALE HOUSING	PBT	BLACK	1
0-2112058-9	A	C	PERIPHERAL SEAL	SILICON	LIGHT BLUE	3
			SPACER	PBT	RED	2a
			FEMALE HOUSING	PBT	BLACK	1
0-2112058-8	A	C	PERIPHERAL SEAL	SILICON	LIGHT BLUE	3
			SPACER	PBT	RED	2a
			FEMALE HOUSING	PBT	BLACK	1
0-2112058-7	A	C	PERIPHERAL SEAL	SILICON	LIGHT BLUE	3
			SPACER	PBT	RED	2a
			FEMALE HOUSING	PBT	BLACK	1
0-2112058-6	A	C	PERIPHERAL SEAL	SILICON	LIGHT BLUE	3
			SPACER	PBT	RED	2a
			FEMALE HOUSING	PBT	BLACK	1
0-2112058-5	A	C	PERIPHERAL SEAL	SILICON	LIGHT BLUE	3
			SPACER	PBT	RED	2a
			FEMALE HOUSING	PBT	BLACK	1
0-2112058-4	A	C	PERIPHERAL SEAL	SILICON	LIGHT BLUE	3
			SPACER	PBT	RED	2a
			FEMALE HOUSING	PBT	BLACK	1
0-2112058-3	A	C	PERIPHERAL SEAL	SILICON	LIGHT BLUE	3
			SPACER	PBT	RED	2a
			FEMALE HOUSING	PBT	BLACK	1
0-2112058-2	A	C	PERIPHERAL SEAL	SILICON	LIGHT BLUE	3
			SPACER	PBT	RED	2a
			FEMALE HOUSING	PBT	BLACK	1
0-2112058-1	A	C	PERIPHERAL SEAL	SILICON	LIGHT BLUE	3
			SPACER	PBT	RED	2a
			FEMALE HOUSING	PBT	BLACK	1

PN. 0-2112058-1 AS SHOWN

REGRIND MAX. 25%

THIS DRAWING IS A CONTROLLED DOCUMENT. DMN H. TRAJKOV 03JUL2009
 CHK H. RIPPER 03JUL2009

DIMENSIONS:	TOLERANCES UNLESS OTHERWISE SPECIFIED:	PRODUCT SPEC	NAME
mm	0 PLC ±0.5 1 PLC ±0.5 2 PLC ±0.5 3 PLC ±0.5 4 PLC ±0.5 ANGLES ±1°	114-94066	8POS. YES 1.5 mm SOCK. HSG. SEALED
MATERIAL		WEIGHT	SIZE CAGE CODE DRAWING NO RESTRICTED TO
			A1 00779 C-2112058
CUSTOMER DRAWING		SCALE	SHEET 1 OF 1 REV C7

4805 (3/11)