

REVISIONS

P	LTR	DESCRIPTION	DATE	DWN	APVD
	BC	ECR-16-000788	18JAN2016	KR	TN
	BC1	ECR-22-127236	21JAN2022	KS	TG

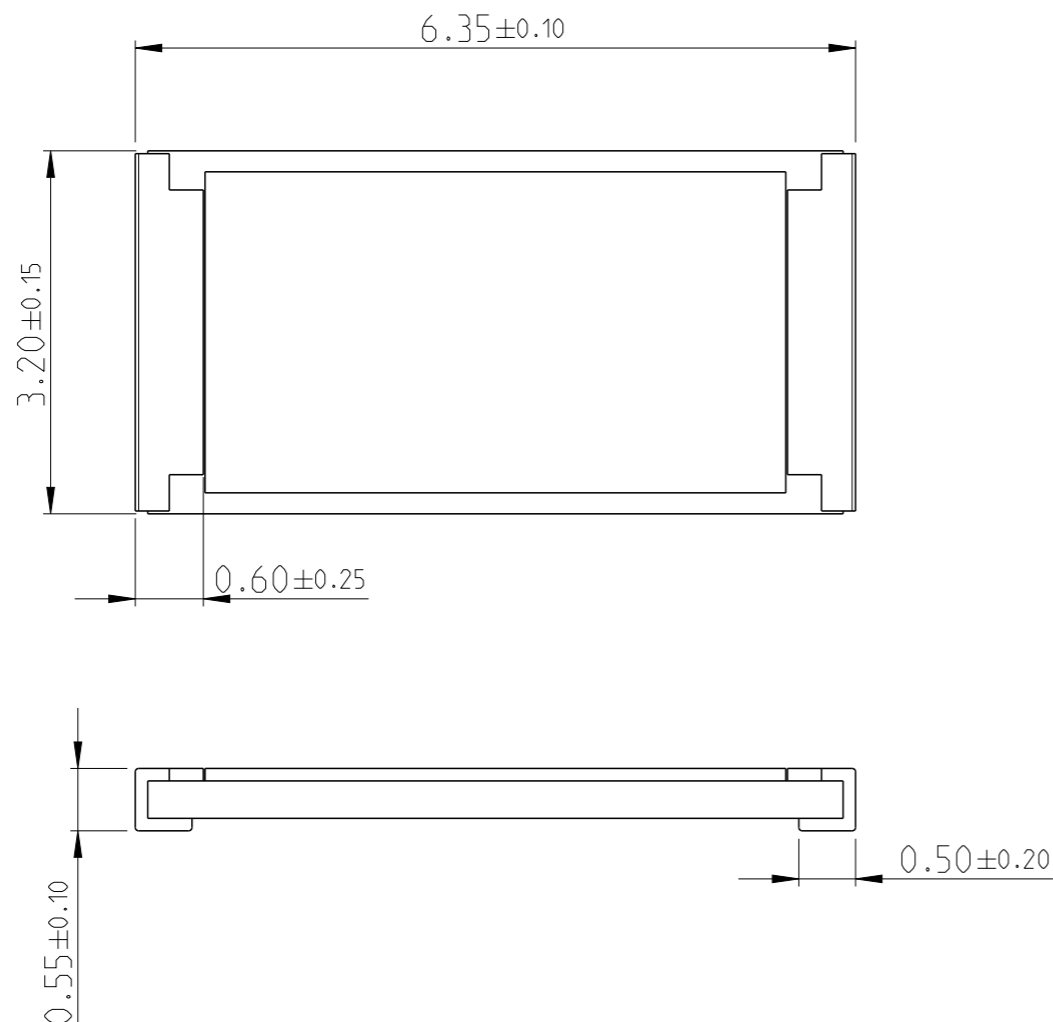

FOR FURTHER INFORMATION SEE PRODUCT SPECIFICATION FOR CRGH SERIES

RoHS Compliant

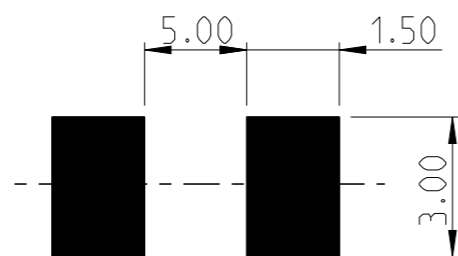

PCB LAYOUT PLAN

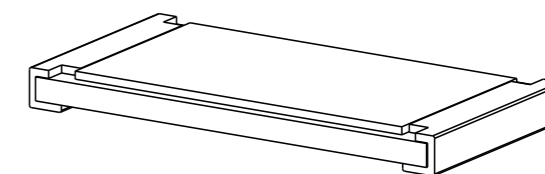

THIS DRAWING IS A CONTROLLED DOCUMENT.

DWN 27JUN2012  
RAGHAVENDRA K  
CHK 27JUN2012  
ALLAN P  
APVD 27JUN2012  
TONY N



DIMENSIONS:	TOLERANCES UNLESS OTHERWISE SPECIFIED:
mm	
	0 PLC ±-
	1 PLC ±0.5
	2 PLC ±0.13
	3 PLC ±0.013
	4 PLC ±0.0001
	ANGLES ±
MATERIAL	FINISH
-	-
-	-

PRODUCT SPEC -

APPLICATION SPEC -

WEIGHT -

CUSTOMER DRAWING

NAME				RESTRICTED TO	
SMD POWER RESISTORS - TYPE CRGH2512 SERIES				-	
SIZE	CAGE CODE	DRAWING NO			
A3	00779	C-1879526			
SCALE		SHEET	OF	REV	
40:1		1	1	BC1	

REVISIONS

P	LTR	DESCRIPTION	DATE	DWN	APVD
-		SEE SHEET 1	-	-	-

TCPN	PART DESCRIPTION	ALIAS
1879526-1	CRGH2512 1% 12K4 2W	CRGH2512F12K4
1879526-2	CRGH2512 1% 12K7 2W	CRGH2512F12K7
1879526-3	CRGH2512 1% 13K 2W	CRGH2512F13K
1879526-4	CRGH2512 1% 13K3 2W	CRGH2512F13K3
1879526-5	CRGH2512 1% 13K7 2W	CRGH2512F13K7
1879526-6	CRGH2512 1% 14K 2W	CRGH2512F14K
1879526-7	CRGH2512 1% 14K3 2W	CRGH2512F14K3
1879526-8	CRGH2512 1% 14K7 2W	CRGH2512F14K7
1879526-9	CRGH2512 1% 15K 2W	CRGH2512F15K
1-1879526-0	CRGH2512 1% 15K4 2W	CRGH2512F15K4
1-1879526-1	CRGH2512 1% 15K8 2W	CRGH2512F15K8
1-1879526-2	CRGH2512 1% 16K2 2W	CRGH2512F16K2
1-1879526-3	CRGH2512 1% 16K5 2W	CRGH2512F16K5
1-1879526-4	CRGH2512 1% 16K9 2W	CRGH2512F16K9
1-1879526-5	CRGH2512 1% 17K4 2W	CRGH2512F17K4
1-1879526-6	CRGH2512 1% 17K8 2W	CRGH2512F17K8
1-1879526-7	CRGH2512 1% 18K2 2W	CRGH2512F18K2
1-1879526-8	CRGH2512 1% 18K7 2W	CRGH2512F18K7
1-1879526-9	CRGH2512 1% 19K1 2W	CRGH2512F19K1
2-1879526-0	CRGH2512 1% 19K6 2W	CRGH2512F19K6
2-1879526-1	CRGH2512 1% 20K 2W	CRGH2512F20K
2-1879526-2	CRGH2512 1% 20K5 2W	CRGH2512F20K5
2-1879526-3	CRGH2512 1% 21K 2W	CRGH2512F21K
2-1879526-4	CRGH2512 1% 21K5 2W	CRGH2512F21K5
2-1879526-5	CRGH2512 1% 22K1 2W	CRGH2512F22K1
2-1879526-6	CRGH2512 1% 22K6 2W	CRGH2512F22K6
2-1879526-7	CRGH2512 1% 23K2 2W	CRGH2512F23K2
2-1879526-8	CRGH2512 1% 23K7 2W	CRGH2512F23K7
2-1879526-9	CRGH2512 1% 24K3 2W	CRGH2512F24K3
3-1879526-0	CRGH2512 1% 24K9 2W	CRGH2512F24K9

TCPN	PART DESCRIPTION	ALIAS
3-1879526-1	CRGH2512 1% 25K5 2W	CRGH2512F25K5
3-1879526-2	CRGH2512 1% 26K1 2W	CRGH2512F26K1
3-1879526-3	CRGH2512 1% 26K7 2W	CRGH2512F26K7
3-1879526-4	CRGH2512 1% 27K4 2W	CRGH2512F27K4
3-1879526-5	CRGH2512 1% 28K 2W	CRGH2512F28K
3-1879526-6	CRGH2512 1% 28K7 2W	CRGH2512F28K7
3-1879526-7	CRGH2512 1% 29K4 2W	CRGH2512F29K4
3-1879526-8	CRGH2512 1% 30K1 2W	CRGH2512F30K1
3-1879526-9	CRGH2512 1% 30K9 2W	CRGH2512F30K9
4-1879526-0	CRGH2512 1% 31K6 2W	CRGH2512F31K6
4-1879526-1	CRGH2512 1% 32K4 2W	CRGH2512F32K4
4-1879526-2	CRGH2512 1% 33K2 2W	CRGH2512F33K2
4-1879526-3	CRGH2512 1% 34K 2W	CRGH2512F34K
4-1879526-4	CRGH2512 1% 34K8 2W	CRGH2512F34K8
4-1879526-5	CRGH2512 1% 35K7 2W	CRGH2512F35K7
4-1879526-6	CRGH2512 1% 36K5 2W	CRGH2512F36K5
4-1879526-7	CRGH2512 1% 37K4 2W	CRGH2512F37K4
4-1879526-8	CRGH2512 1% 38K3 2W	CRGH2512F38K3
4-1879526-9	CRGH2512 1% 39K2 2W	CRGH2512F39K2
5-1879526-0	CRGH2512 1% 40K2 2W	CRGH2512F40K2
5-1879526-1	CRGH2512 1% 41K2 2W	CRGH2512F41K2
5-1879526-2	CRGH2512 1% 42K2 2W	CRGH2512F42K2
5-1879526-3	CRGH2512 1% 43K2 2W	CRGH2512F43K2
5-1879526-4	CRGH2512 1% 44K2 2W	CRGH2512F44K2
5-1879526-5	CRGH2512 1% 45K3 2W	CRGH2512F45K3
5-1879526-6	CRGH2512 1% 46K4 2W	CRGH2512F46K4
5-1879526-7	CRGH2512 1% 47K5 2W	CRGH2512F47K5
5-1879526-8	CRGH2512 1% 48K7 2W	CRGH2512F48K7
5-1879526-9	CRGH2512 1% 49K9 2W	CRGH2512F49K9
6-1879526-0	CRGH2512 1% 51K1 2W	CRGH2512F51K1

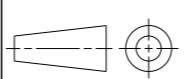
THIS DRAWING IS A CONTROLLED DOCUMENT.		DWN RAGHAVENDRA K 27 JUN 2012	 TE Connectivity	
DIMENSIONS: mm		CHK ALLAN P 27 JUN 2012		
TOLERANCES UNLESS OTHERWISE SPECIFIED:		APVD TONY N 27 JUN 2012	NAME SMD POWER RESISTORS - TYPE CRGH2512 SERIES	
		PRODUCT SPEC -	APPLICATION SPEC -	
MATERIAL -		FINISH -	WEIGHT -	RESTRICTED TO -
CUSTOMER DRAWING			SIZE A3	CAGE CODE 00779
SCALE 40:1			DRAWING NO C=1879526	SHEET 1 OF 1
			REV BC1	

REVISIONS

P	LTR	DESCRIPTION	DATE	DWN	APVD
-		SEE SHEET 1	-	-	-

TCPN	PART DESCRIPTION	ALIAS
6-1879526-1	CRGH2512 1% 52K3 2W	CRGH2512F52K3
6-1879526-2	CRGH2512 1% 53K6 2W	CRGH2512F53K6
6-1879526-3	CRGH2512 1% 54K9 2W	CRGH2512F54K9
6-1879526-4	CRGH2512 1% 56K2 2W	CRGH2512F56K2
6-1879526-5	CRGH2512 1% 57K6 2W	CRGH2512F57K6
6-1879526-6	CRGH2512 1% 59K 2W	CRGH2512F59K
6-1879526-7	CRGH2512 1% 60K4 2W	CRGH2512F60K4
6-1879526-8	CRGH2512 1% 61K9 2W	CRGH2512F61K9
6-1879526-9	CRGH2512 1% 63K4 2W	CRGH2512F63K4
7-1879526-0	CRGH2512 1% 64K9 2W	CRGH2512F64K9
7-1879526-1	CRGH2512 1% 66K5 2W	CRGH2512F66K5
7-1879526-2	CRGH2512 1% 68K1 2W	CRGH2512F68K1
7-1879526-3	CRGH2512 1% 69K8 2W	CRGH2512F69K8
7-1879526-4	CRGH2512 1% 71K5 2W	CRGH2512F71K5
7-1879526-5	CRGH2512 1% 73K2 2W	CRGH2512F73K2
7-1879526-6	CRGH2512 1% 75K 2W	CRGH2512F75K
7-1879526-7	CRGH2512 1% 76K8 2W	CRGH2512F76K8
7-1879526-8	CRGH2512 1% 78K7 2W	CRGH2512F78K7
7-1879526-9	CRGH2512 1% 80K6 2W	CRGH2512F80K6
8-1879526-0	CRGH2512 1% 82K5 2W	CRGH2512F82K5

TCPN	PART DESCRIPTION	ALIAS
8-1879526-1	CRGH2512 1% 84K5 2W	CRGH2512F84K5
8-1879526-2	CRGH2512 1% 86K6 2W	CRGH2512F86K6
8-1879526-3	CRGH2512 1% 88K7 2W	CRGH2512F88K7
8-1879526-4	CRGH2512 1% 90K9 2W	CRGH2512F90K9
8-1879526-5	CRGH2512 1% 93K1 2W	CRGH2512F93K1
8-1879526-6	CRGH2512 1% 95K3 2W	CRGH2512F95K3
8-1879526-7	CRGH2512 1% 97K6 2W	CRGH2512F97K6
8-1879526-8	CRGH2512 1% 100K 2W	CRGH2512F100K
8-1879526-9	CRGH2512 1% 102K 2W	CRGH2512F102K
9-1879526-0	CRGH2512 1% 105K 2W	CRGH2512F105K
9-1879526-1	CRGH2512 1% 107K 2W	CRGH2512F107K
9-1879526-2	CRGH2512 1% 110K 2W	CRGH2512F110K
9-1879526-3	CRGH2512 1% 113K 2W	CRGH2512F113K
9-1879526-4	CRGH2512 1% 115K 2W	CRGH2512F115K
9-1879526-5	CRGH2512 1% 118K 2W	CRGH2512F118K
9-1879526-6	CRGH2512 1% 121K 2W	CRGH2512F121K
9-1879526-7	CRGH2512 1% 124K 2W	CRGH2512F124K
9-1879526-8	CRGH2512 1% 127K 2W	CRGH2512F127K
9-1879526-9	CRGH2512 1% 130K 2W	CRGH2512F130K

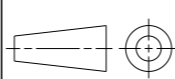
THIS DRAWING IS A CONTROLLED DOCUMENT.		DWN RAGHAVENDRA K 27 JUN 2012	 TE Connectivity	
DIMENSIONS: mm		CHK ALLAN P 27 JUN 2012		
		APVD TONY N 27 JUN 2012	NAME SMD POWER RESISTORS - TYPE CRGH2512 SERIES	
TOLERANCES UNLESS OTHERWISE SPECIFIED: 0 PLC ± 1 PLC ±0.5 2 PLC ±0.13 3 PLC ±0.013 4 PLC ±0.0001 ANGLES ±		PRODUCT SPEC -	APPLICATION SPEC -	
MATERIAL -		FINISH -	WEIGHT -	SIZE A3
		CAGE CODE 00779		DRAWING NO C-1879526
		RESTRICTED TO -		SCALE 40:1
		CUSTOMER DRAWING		SHEET 1 OF 1
				REV BC1