



**NOTE**

All numerical values are in metric units [with U.S. customary units in brackets]. Dimensions are in millimeters [and inches]. Unless otherwise specified, dimensions have a tolerance of  $\pm 0.13$  [ $\pm 0.005$ ] and angles have a tolerance of  $\pm 2^\circ$ . Figures and illustrations are for identification only and are not drawn to scale.

**1. INTRODUCTION**

This specification covers the requirements for application of Multi beam CE connectors onto printed circuit (pc) boards for use in computer and electronic equipment. The connectors are designed to connect a module pc board (daughter card) to a main pc board (motherboard). These connectors are available in vertical, right-angle, or straddle-mount configuration with through-hole, press-fit (compliant pin), or surface-mount contacts. Each connector has a double row of contact cavities with a centerline spacing of 7.26 mm for power contacts and 1.00mm for signal contacts. All connectors, except the straddle-mount configuration, feature standoffs to allow easy pc board cleaning after soldering.

Product Configuration	Solder Tail	Press-fit Tail
MBCE Vertical Receptacle	Yes	Yes
MBCE Right Angle Receptacle	Yes	/
MBCE Straddle Mount	Yes	/

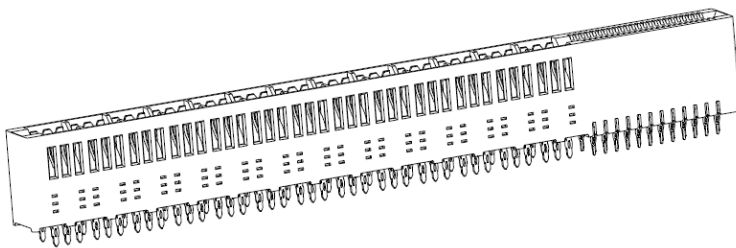

Vertical Receptacle

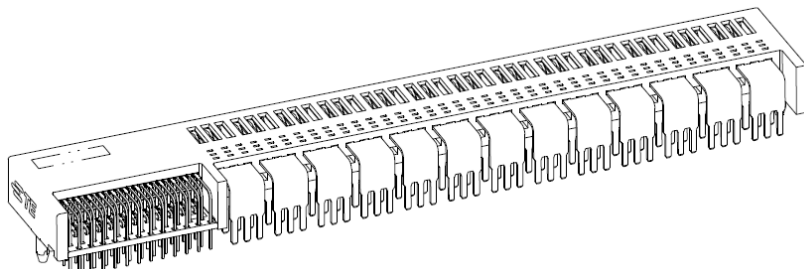

Right angle Receptacle

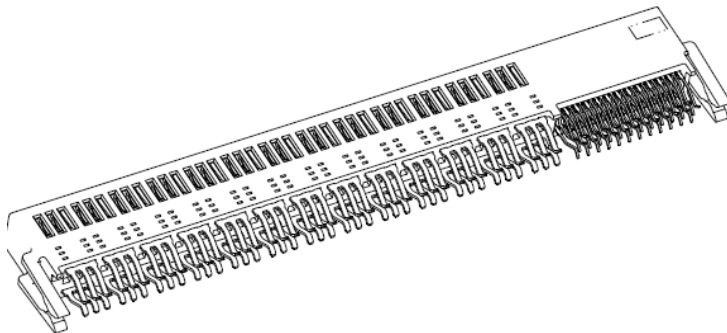

Straddle Mount Receptacle

---

## 2. REFERENCE MATERIAL

### 2.1. Revision Summary

Initial release of application specification

### 2.2. Customer Assistance

Reference Product Base Part Number 2412913, 2212115, 2212078 and Product Code EE24 are representative of these connectors. Use of these numbers will identify the product line and help you to obtain product and tooling information. Such information can be obtained through a local Representative, by visiting our website at [www.te.com](http://www.te.com), or by calling PRODUCT INFORMATION or the TOOLING ASSISTANCE CENTER at the numbers at the bottom of page 1.

### 2.3. Drawings

Customer Drawings for product part numbers are available from the service network. If there is a conflict between the information contained in the Customer Drawings and this specification or with any other technical documentation supplied, the information contained in the Customer Drawings takes priority

### 2.4. Manuals

Manuals (402-series) can be used as a guide to soldering. These manuals provide information on various flux types and characteristics with the commercial designation, flux removal procedures, and a guide for information on soldering problems. Documents available which pertain to this product are:

- 402-40 Solderability and Soldering
- 402-58-1 Lead-Free Soldering Guidelines for Wave Soldering Specific to Power Products
- 502-58-2 Lead-Free Soldering Guidelines for Reflow Soldering Specific to Power Products

### 2.5. Specifications

Product Specifications (108-series) provide product performances and test information.

- 108-32043 Multi-beam CE Card Edge connector

Qualification Test Report (501-series) is a test report confirming successful qualification of the information in product specifications. Document available which pertain to this product is:

- 501-128025 Multi-beam CE Card Edge connector

Test Specification 109-11 provides solderability requirements and evaluation methods, and workmanship Specification 101-21 provides solder fillet requirements.

## 3. REQUIREMENTS

### 3.1. Safety

Do not stack component packages so high that the shipping containers buckle or deform.

### 3.2. Limitations

These connectors are designed to operate in a temperature range of -55°C to 105°C.

### 3.3. Material

The connector housing is made of glass-filled polyester. The contacts are made of copper alloy plated with nickel; Contact areas are plated with precious metal and press-fit contacts tines and solder tines are plated with tin.

### 3.4. Storage

#### A. Ultraviolet Light

Prolonged exposure to ultraviolet light may deteriorate the chemical composition used in the product material.

#### B. Shelf Life

The product should remain in the shipping containers until ready for use to prevent deformation to components. The product should be used on a first in, first out basis to avoid storage contamination that could adversely affect performance.

#### C. Chemical Exposure

Do not store product near any chemical listed below as they may cause stress corrosion cracking in the material.

Alkalies	Ammonia	Citrates	Phosphates	Citrates	Sulfur Compounds
Amines	Carbonates	Nitrites	Sulfur Nitrites		Tartrates

### 3.5. PC Board (Motherboard)

#### A. Material and Thickness

The pc board material shall be glass epoxy (FR-4 or G-10). The pc board thickness range shall be  $1.57 \pm 0.20\text{mm}$  or  $2.36 \pm 0.20\text{mm}$  for connectors with surface-mount contacts. Detailed information refer to customer drawings.

#### B. Tolerance

Maximum allowable bow of the pc board shall be 0.03mm over the length if the connector. For connectors with press-fit contacts, maximum allowable recycle of the pc board holes shall be three times.

#### C. Pads

For connectors with surface-mount contacts, the pc board circuit pads must be solderable in accordance with test specification 109-11.

#### D. Hole Dimensions

The holes in the pc board for through-hole contacts, press-fit contacts, and formed posts must be drilled and plated through to specific dimensions. The plating type and thickness and finished hole size must be as stated to provide unrestricted insertion. See figure1.

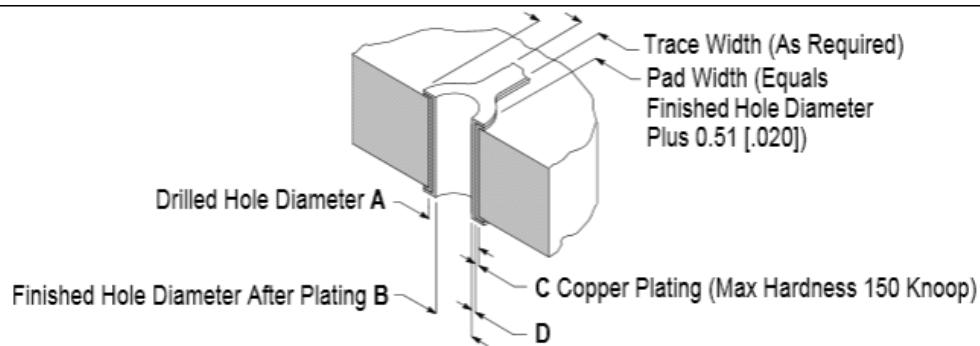

CONNECTOR CONTACT TYPE		DIMENSION (mm)				
		A	B	C	D	
					SURFACE FINISH	THICKNESS
Power contact	Through-Hole	1.20 ±0.03	1.07 ±0.05	0.051 ±0.025	Tin-Lead (SnPb)	0.008(Min)
					Immersion Tin (Sn)	0.0005-0.004
					Organic Solderability Preservative (OSP)	0.0002-0.0005
					Immersion Gold (Au) Over Nickel (Ni) (ENIG)	0.0001-0.0005 Au 0.004-0.0051 Ni
					Immersion Silver (Ag)	0.0001-0.0005
	Press-Fit	1.20 ±0.03	1.07 ±0.05	0.025 -0.050	Hot Air Solder Leveling (HASL) Tin-Lead (SnPb)	0.004-0.010
					Immersion Tin (Sn)	0.0005-0.004
					Organic Solderability Preservative (OSP)	0.0002-0.0005
					Immersion Gold (Au) Over Nickel (Ni) (ENIG)	0.0001-0.0005 Au 0.004-0.0051 Ni
					Immersion Silver (Ag)	0.0001-0.0005
Signal contact	Through-Hole	0.78 ±0.03	0.70 ±0.05	0.051 ±0.025	Tin-Lead (SnPb)	0.008(Min)
					Immersion Tin (Sn)	0.0005-0.004
					Organic Solderability Preservative (OSP)	0.0002-0.0005
					Immersion Gold (Au) Over Nickel (Ni) (ENIG)	0.0001-0.0005 Au 0.004-0.0051 Ni
					Immersion Silver (Ag)	0.0001-0.0005
	Press-Fit	0.78 ±0.03	0.70 ±0.05	0.025 -0.050	Hot Air Solder Leveling (HASL) Tin-Lead (SnPb)	0.004-0.010
					Immersion Tin (Sn)	0.0005-0.004
					Organic Solderability Preservative (OSP)	0.0002-0.0005
					Immersion Gold (Au) Over Nickel (Ni) (ENIG)	0.0001-0.0005 Au 0.004-0.0051 Ni
					Immersion Silver (Ag)	0.0001-0.0005

Figure 1

### E. Layout

The holes (for through-hole contacts, press-fit contacts, and formed posts) or pads (for surface-mount contacts) on the pc board must be precisely located to ensure proper placement and optimum performance of the connector. The pc board layout must be designed using the dimensions provided on the customer drawing for the specific connector. A typical recommended pc board layout for each is shown in Figure 2

**Typical Recommended PC Board (Motherboard) Layout**

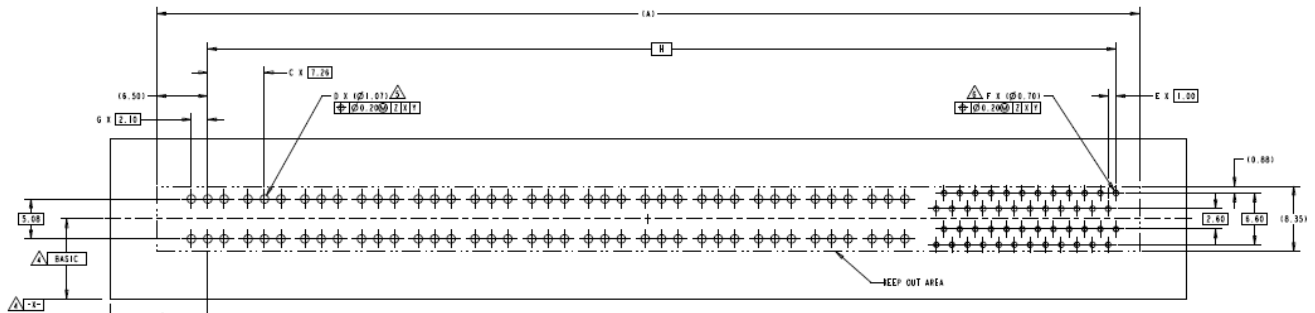

Datum and Basic Dimensions Established by Customer

**Typical Recommended Daughter Card Configuration**

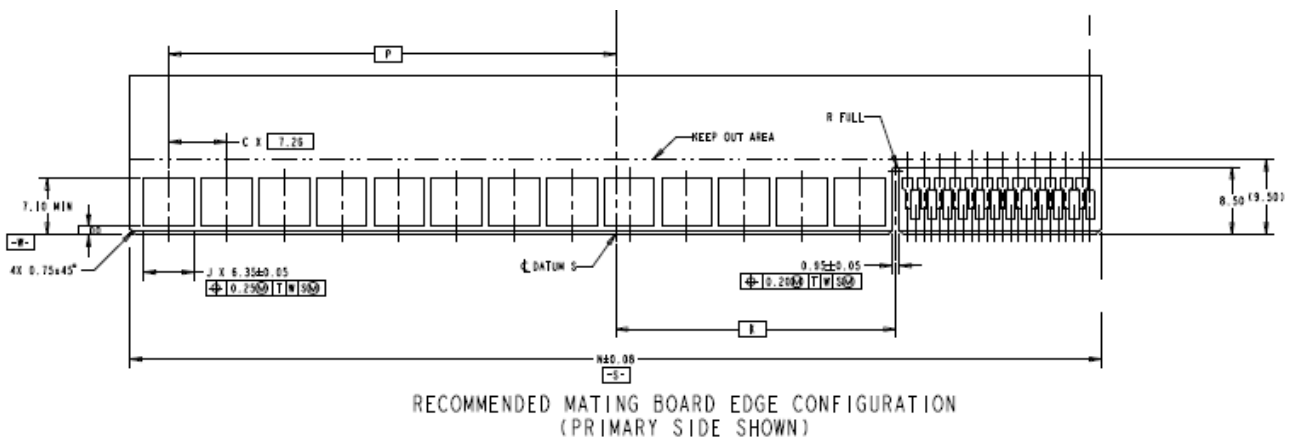

RECOMMENDED MATING BOARD EDGE CONFIGURATION  
(PRIMARY SIDE SHOWN)

### Connector with Surface-Mount Contacts

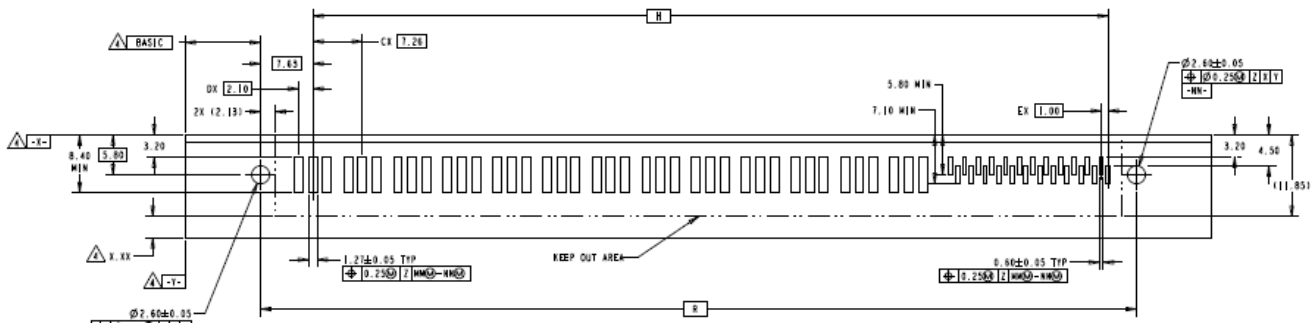

Figure 2

### 3.6. Soldering

#### A. Connector with Through-Hole Contacts- Tin Plated

Observe guidelines and procedures when soldering contacts. All solder joints should conform to those specified in Workmanship Specification 101-21 and all other requirements specified in this document. Solder, clean, and dry all wire leads to contacts according to the following:

##### 1. Flux Selection

Contact solder tines must be fluxed prior to soldering with a mildly active, rosin base flux. Selection of the flux will depend on the type of pc board and other components mounted on the board. Additionally, the flux must be compatible with the wave solder line, manufacturing, health, and safety requirements. Call PRODUCT INFORMATION at the number at the bottom of page 1 for consideration of other types of flux. Flux that is compatible with these connectors are provided in Figure 3.

FLUX TYPE	ACTIVITY	RESIDUE	COMMERCIAL DESIGNATION	
			KESTER	ALPHA
RMA	Mild	Noncorrosive	186	611

Figure 3

##### 2. Process

The connectors can be soldered using wave soldering or equivalent soldering techniques. It is recommended using SN60, SN62, or tin solder for these connectors. The temperatures and exposure time shall be as specified in Figure 4

SOLDERING PROCESS	TEMPERATURE	TIME (At Max Temperature)
Wave	265°C [509°F] (Wave Temperature)	5 Seconds

Figure 4

##### 3. Cleaning

After soldering, removal of fluxes, residues, and activators is necessary. Consult with the supplier of the solder and flux for recommended cleaning solvents. Cleaners must be free of dissolved flux and other contaminants. It is recommended that cleaning takes place with the pc board on its edge. The following is a list of common cleaning solvents that will not affect connectors for the time and temperature specified. See Figure 5.

**NOTE**  Even when using "no clean" solder paste, it is imperative that the contact interface be kept clean of flux and residue, since it acts as an insulator. Flux may migrate under certain conditions with elevated temperatures and, therefore, cleaning is necessary.

CLEANER		TIME (Minutes)	TEMPERATURE (Maximum)
NAME	TYPE		
ALPHA 2110	Aqueous	1	132°C [270°F]
BIOACT EC-7	Solvent	5	100°C [212°F]
Butyl CARBITOL	Solvent	1	Ambient Room
Isopropyl Alcohol	Solvent	5	100°C [212°F]
KESTER 5778	Aqueous		
KESTER 5779	Aqueous		
LONCOTERGE 520	Aqueous		
LONCOTERGE 530	Aqueous		
Terpene	Solvent		

Figure 5

**DANGER**  Consideration must be given to toxicity and other safety requirements recommended by the solvent manufacturer. Refer to the manufacturer's Material Safety Data Sheet (MSDS) for characteristics and handling of cleaners. It is recommended to not use Trichloroethylene and Methylene Chloride because of harmful occupational and environmental effects. Both are carcinogenic (cancer-causing).

**4. Drying**

When drying cleaned assemblies and pc boards, make certain that temperature limitations are not exceeded: -55° to 105°C [-67° to 221°F]. Excessive temperatures may cause housing degradation.

**B. Connector with Surface-Mount contacts- Tin plated**

1. Solder Paste Characteristics

- a. Alloy type shall be 63 Sn/37 Pb, 60 Sn/40 Pb, or 62 Sn/36 Pb/2 Ag.
- b. Flux incorporated in the paste shall be rosin, mildly active (RMA) type.
- c. Paste will be at least 80% solids by volume.
- d. Mesh designation -200 to +325 (74 to 44 square micron openings, respectively).
- e. Minimum viscosity of screen print shall be 5x10% cp (centipoise).
- f. Minimum viscosity of stencil print shall be 7.5x10% cp (centipoise).

2. Solder volume

Minimum solder volume (V) (before curing) for each circuit pad is calculated by multiplying the pad length (L) by the pad width (W) by the stencil thickness (T):

$$0.00(L) \times 0.00(W) \times 0.00(T) = 0.15 \text{ mm}^3 (V)$$

Solder volume for each connector must be 0.11 mm<sup>3</sup> per contact solder tine.

Solder volume may vary depending on solder paste composition.

3. Solder Paste Thickness

Solder paste thickness for the solder tines shall be 0.20 mm.

4. Screen (or Stencil)

Recommended screen (or Stencil) thickness is 0.76mm with 0.51mm diameter openings.



*All traces must be covered by solder mask in the solder deposit area. Exposed traces could cause bridging and create a short, or wick solder away from the solder tines, producing a weak solder joint.*

#### 4. QUALIFICATION

by Underwriters Laboratories Inc. (UL) in File E and for CSA International.

#### 5. TOOLING

No tooling is required for manual placement of the connectors onto the pc board. Manually-operated tools, and automatic and semi-automatic machines for power assisted application of the connectors are available. The application tooling must provide sufficient amount of downward force to insert the contacts into the pc board holes. Instructional material packaged with the tooling is shown in Figure 6.

##### 5.1. Manual Tools

For low-volume production, commercial hand-operated arbor presses are available. For seating connectors with press-fit contacts, the Greenerd manual frame assembly must be fitted with an adapter kit. The adapter kit includes a board support plate.

##### 5.2. Power Units

Power units are designed for high-volume production. SM-3 machine is a pneumatic bench-mounted power unit controlled manually with pc board sensing or pressure sensing operation.

##### 5.3. Robotic Equipment

Robotic equipment must have a true position accuracy tolerance of 0.25 mm [.010 in.] to feed, pick up, and place the connectors on the pc board. This includes gripper and fixture tolerances as well as equipment repeatability.

##### 5.4. Housing Support

A housing support with sides and ends as close as possible to the connector housing is recommended when removing connectors with press-fit contacts from the pc board. The support protects the housing from damage.

##### 5.5. PC Board Support (Customer Supplied)

When using application tooling, a pc board support must be used to provide proper support for the pc board and to protect the pc board and connector from damage. It is also recommended using the pc board support when removing connectors with press-fit contacts from the board. The board support fixture must be designed for specific needs using the following recommendations:

- it should be at least 25.4 mm [1.0 in.] wider than the pc board
- it should have a flat surface with a cutout or holes to allow adequate clearance for the contacts

##### 5.6. Seating Tool

Seating tool is required to seat vertical press-fit connectors onto the pc board. Each seating tool is specifically designed for the number of contact positions and molded key position in the connector. Power for the seating tool must be provided by application tooling (with a ram) capable of supplying a downward force of 67 Newtons (N) [15 lb] per contact.



5.7. Pushing Bar (Flat Rock)

Commercially available bar stock with a flat surface large enough to cover all contacts can be used to seat connectors with signal contacts only. The push bar must be used with application tooling. The push bar is also used to remove a connector from the pc board.

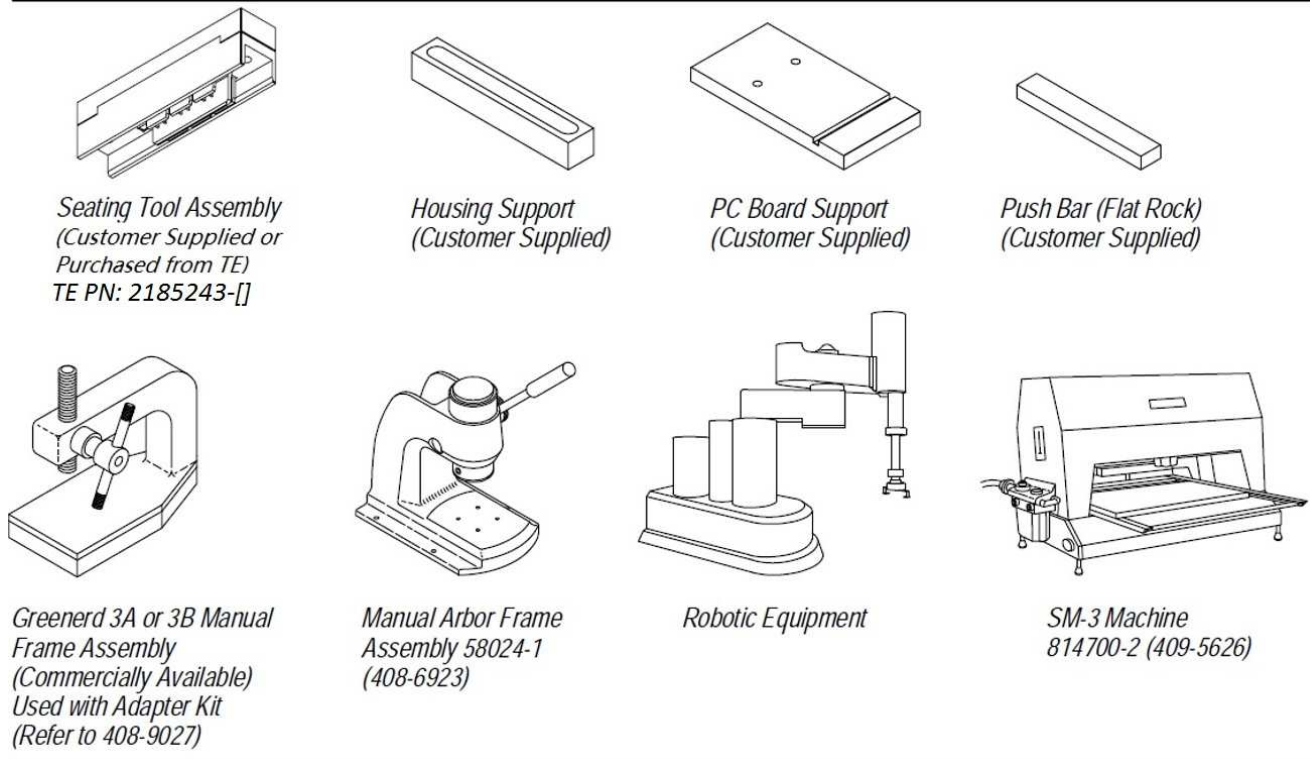

Figure 6

## 6. VISUAL AID

The illustration below shows a typical application of this product. This illustration should be used by production personnel to ensure a correctly applied product. Applications which DO NOT appear correct should be inspected using the information in the preceding pages of this specification and in the instructional material shipped with the product or tooling.

**FIGURE 7. VISUAL AID**

### **CONNECTOR WITH PRESS-FIT OR THROUGH-HOLE CONTACTS**

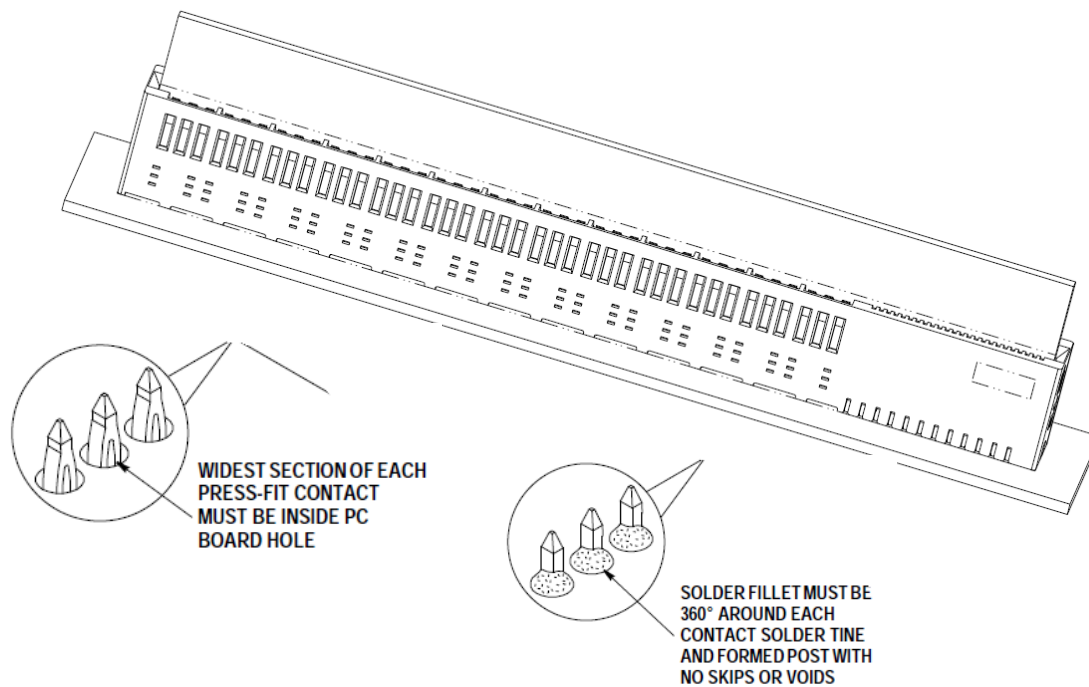

**CONNECTOR WITH  
SURFACE-MOUNT CONTACTS**

