

Type III+ (Size 16) Contacts

NOTE

All numerical values are in metric units [with U.S. customary units in brackets]. Dimensions are in millimeters [and inches]. Unless otherwise specified, dimensions have a tolerance of ± 0.13 [$\pm .005$] and angles have a tolerance of $\pm 2^\circ$. Figures and illustrations are for identification only and are not drawn to scale.

1. INTRODUCTION

This specification covers the requirements for application of Type III+ (Size 16) Contacts. These contacts have a pin diameter of 1.57 mm [.062 in.]. A color dot appears on the loose piece or (loose piece only) contact spring which designates the applicable wire size and matches the color dot above the hand tool crimping section. These requirements apply to hand or automatic machine crimping tools for the insulated grip contacts.

When corresponding with TE Connectivity Personnel, use the terminology provided in this specification to facilitate inquiries for information. Basic terms and features of this product are provided in Figure 1.

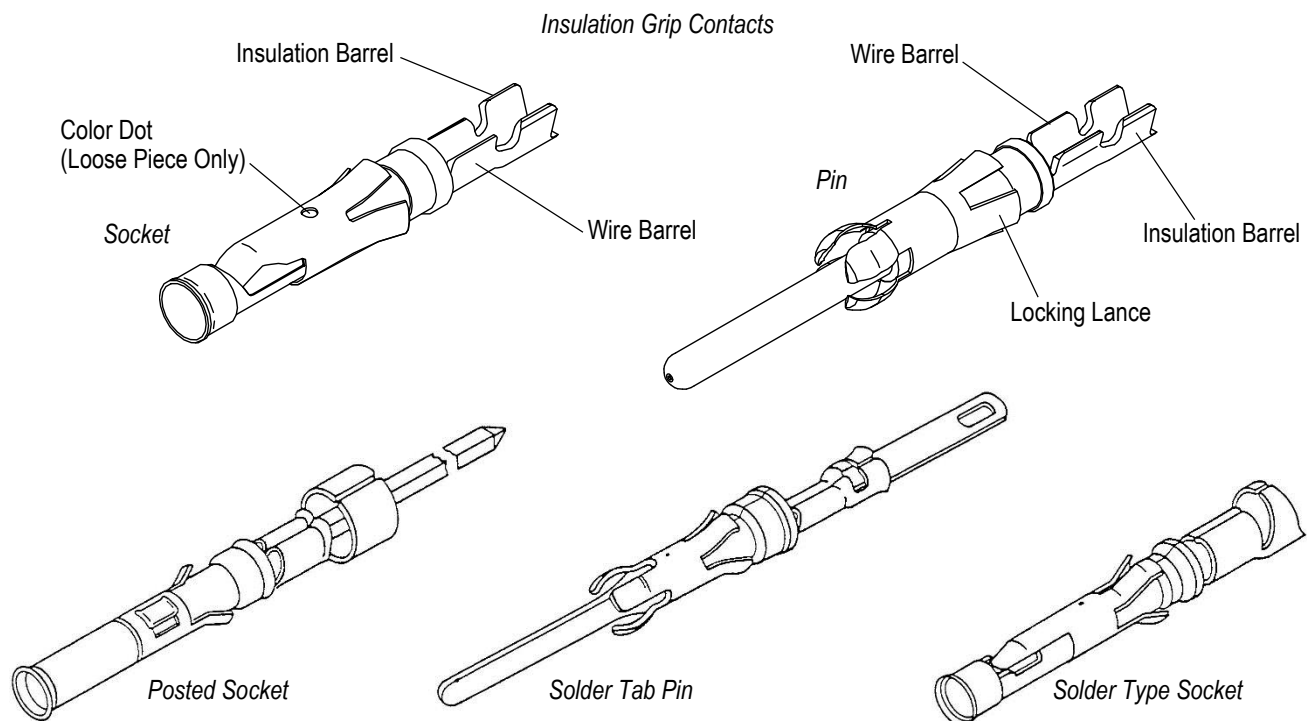

Figure 1

2. REFERENCE MATERIAL
2.1. Revision Summary

- Updated document to corporate requirements
- Changed information in Paragraph 2.6, and tables in Figures 2 and 6

2.2. Customer Assistance

Reference Product Base Part Number 66098 and Product Code 5022 are representative of the Type III+ (Size 16) Contacts. Use of these numbers will identify the product line and help you to obtain product and tooling information. Such information can be obtained through a local TE Representative, by visiting our website at www.te.com, or by calling PRODUCT INFORMATION or the TOOLING ASSISTANCE CENTER at the numbers at the bottom of this page.

2.3. Drawings

Customer Drawings for product part numbers are available from our website at www.te.com. If there is a conflict between the information contained in the Customer Drawings and this specification or with any other technical documentation supplied, the information contained in the Customer Drawings takes priority.

2.4. Manuals

Manual 402-40 can be used as a guide to soldering. This manual provides information on various flux types and characteristics with the commercial designation and flux removal procedures. A checklist is included in the manual as a guide for information on soldering problems.

2.5. Specifications

Product Specification 108-10042 provides product performance and test results.

2.6. Instructional Material

Instruction sheets (408-series) provide product assembly instructions or tool setup and operation procedures. Instruction sheets available that pertain to this product are:

<u>Document Number</u>	<u>Document Title</u>
408-1216	Extraction Tools 305183-[]
408-1379	Selection Charts for Multimate Pin and Socket Contacts
408-3295	Preparing Reel of Contacts for Application Tooling
408-7347	Insertion Tools 91002-[]
408-7424	Checking Terminal Crimp Height or Gaging Die Closure
408-8039	Heavy Duty Miniature Quick-Change Applicators (End-Feed Type)
408-8040	Heavy Duty Miniature Quick-Change Applicators (Side-Feed Type)
408-8059	General Preventive Maintenance for Applicators
408-8547	CERTI-CRIMP* II Straight action Hand Tools
408-9640	Crimp Quality Monitor Applicators for Side-Feed and End-Feed Applications
408-9816	Handling of Reeled Products
408-10389	Ocean Side-Feed Applicators
409-5870	Crimp Quality Monitors (CQM) for AMPOMATOR* CLS IV Lead-Making Machines
409-10012	AMP-O-MATIC* Side Feed Stripper-Crimper III Machine 1320895-[]
409-32034	AMP 3K* Terminating Machine 1725950-[] and AMP 5K Terminating Machine 1725900-[]
409-32035	AMP-O-ELECTRIC Model G II Terminator 2217000-[]

3. REQUIREMENTS

3.1. Storage

A. Ultraviolet Light

Prolonged exposure to ultraviolet light may deteriorate the chemical composition used in the product material.

B. Shelf Life

The product should remain in the shipping containers until ready for use to prevent deformation to components. The product should be used on a first in, first out basis to avoid storage contamination that could adversely affect performance.

C. Reel Storage

When using reeled contacts, store coil wound reels horizontally and traverse wound reels vertically.

D. Chemical Exposure

Do not store product near any chemical listed below as they may cause stress corrosion cracking in the material.

Alkalies	Ammonia	Citrates	Phosphates	Citrates	Sulfur Compounds
Amines	Carbonates	Nitrites	Sulfur Nitrites		Tartrates



NOTE

Where the above environmental conditions exist, phosphor-bronze contacts are recommended instead of brass if available.

3.2. Special Characteristics

The solder type and solder tab versions will accept various sizes of solid or stranded wire. For soldering requirements, follow the recommendations of the wire manufacturer and soldering equipment manufacturer. Refer to Manual 402-40.

3.3. Wire Selection and Preparation

The total wire size range for these contacts is 30 through 14 AWG. The wire must be stripped to the dimensions shown in Figure 2.



NOTE

The applied crimp dimension (within the functional range of the product) is dependent on the termination tooling being used. Refer to the documentation (applicator logs and instruction sheets) supplied with the termination tooling for the applied crimp height. See Section 5, TOOLING.



CAUTION

DO NOT nick, scrape, or cut the wire conductor during the stripping operation.

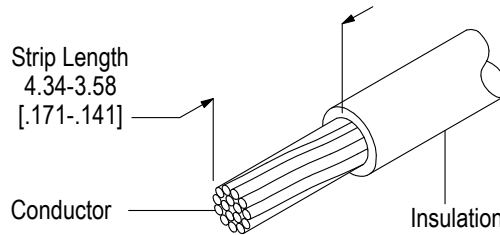

WIRE SIZE (AWG)	INSULATION DIAMETER	WIRE BARREL CRIMP		INSULATION BARREL CRIMP WIDTH
		HEIGHT	WIDTH	
30-26	0.36-0.76 [.014-.030]	1.05-0.89 [.0415-.035]	1.75-1.57 [.069-.062]	1.60-1.20 [.063-.047]
	1.02-1.52 [.040-.060]	1.05-0.89 [.0415-.035]	1.75-1.57 [.069-.062]	1.98-1.58 [.078-.062]
26	0.89-1.40 [.035-.055]	0.84-0.74 [.033-.029]	1.57-1.40 [.062-.055]	1.98-1.58 [.078-.062]
24	2.03-2.54 [.080-.100]	1.04-0.86 [.041-.034]	1.75-1.57 [.069-.062]	3.25-2.85 [.128-.112]
	1.52-3.43 [.060-.135]	0.97-0.76 [.038-.030]	1.75-1.57 [.069-.062]	3.25-2.85 [.128-.112]
	1.02-2.03 [.040-.080]	1.05-0.86 [.0415-.034]	1.75-1.57 [.069-.062]	2.49-2.09 [.098-.082]
	0.89-1.40 [.035-.055]	0.89-0.74 [.035-.029]	1.57-1.40 [.062-.055]	1.98-1.58 [.078-.062]
2 (24)	1.52-3.43 [.060-.135]	1.07-0.86 [.042-.034]	1.75-1.57 [.069-.062]	3.25-2.84 [.128-.112]
	1.02-2.03 [.040-.080]	1.07-0.97 [.042-.038]	1.75-1.57 [.069-.062]	2.49-2.09 [.098-.082]
22	1.02-2.03 [.040-.080]	1.04-0.91 [.041-.036]	1.75-1.57 [.069-.062]	3.25-2.85 [.128-.112]
	1.52-3.43 [.060-.135]	1.02-0.81 [.040-.032]	1.75-1.57 [.069-.062]	3.25-2.84 [.128-.112]
	1.02-2.03 [.040-.080]	1.05-0.91 [.0415-.036]	1.75-1.57 [.069-.062]	2.49-2.09 [.098-.082]

Figure 2 (cont'd)

WIRE SIZE (AWG)	INSULATION DIAMETER	WIRE BARREL CRIMP		INSULATION BARREL CRIMP WIDTH
		HEIGHT	WIDTH	
20	2.03-2.54 [.080-.100]	1.12-0.94 [.044-.037]	1.75-1.57 [.069-.062]	3.25-2.85 [.128-.112]
	1.52-3.43 [.060-.135]	1.12-0.91 [.044-.036]	1.75-1.57 [.069-.062]	3.25-2.84 [.128-.112]
	1.02-2.03 [.040-.080]	1.12-0.95 [.044-.0375]	1.75-1.57 [.069-.062]	2.49-2.09 [.098-.082]
18	2.79-3.81 [.110-.150]	1.37-1.24 [.054-.049]	2.46-2.29 [.097-.090]	4.16-3.76 [.163-.147]
	2.03-2.54 [.080-.100]	1.35-1.24 [.053-.049]	2.20-2.03 [.087-.080]	3.25-2.85 [.128-.112]
16	2.79-3.81 [.110-.150]	1.55-1.24 [.061-.049]	2.46-2.29 [.097-.090]	4.16-3.76 [.163-.147]
	2.03-2.54 [.080-.100]	1.47-1.24 [.058-.049]	2.20-2.03 [.087-.080]	3.25-2.85 [.128-.112]
14	2.79-3.81 [.110-.150]	1.78-1.68 [.070-.066]	2.46-2.29 [.097-.090]	4.16-3.76 [.163-.147]
	2.03-2.54 [.080-.100]	1.78-1.68 [.070-.066]	2.46-2.29 [.097-.090]	3.25-2.85 [.128-.112]
1 mm ²	1.45-1.80 [.057-.071]	1.35-1.24 [.053-.049]	2.20-2.03 [.087-.080]	3.25-2.85 [.128-.112]
0.75 mm ²	1.35-1.65 [.053-.065]	1.27-1.17 [.050-.046]	2.20-2.03 [.087-.080]	3.25-2.85 [.128-.112]

Figure 2 (end)

3.4. Crimped Contact Requirements

The contact must be crimped onto the wire according to instructions packaged with applicable tooling. After crimping, the contact should appear as shown in Figure 3. A typical pin contact is shown as it should appear after crimping; these requirements apply equally to the socket contact.



CAUTION

The wire insulation must not be damaged during the crimping process.

A. Wire Barrel Crimp

The crimp applied to the wire portion of the contact is the most compressed area and is most critical in ensuring optimum electrical and mechanical performance of the crimped contact. The contact wire barrel crimp height must be within the dimension provided in Figure 2.

B. Effective Crimp Length

For optimum crimp effectiveness, the crimp must be within the area shown in Figure 3 and must meet the crimp dimensions provided in Figure 2. Effective crimp length shall be defined as that portion of the wire barrel, excluding bellmouth(s), fully formed by the crimping tool. Instructions for adjusting, repairing, and inspecting tools are packaged with the tools. See Section 5, TOOLING.

C. Bellmouths

Front and rear bellmouths shall be evident and conform to the dimensions given in Figure 3.

D. Cutoff Tabs

The cutoff tab shall be cut to the dimensions shown in Figure 3.

E. Burrs

The cutoff burr shall not exceed the dimensions shown in Figure 3.

F. Wire Barrel Flash

The wire barrel flash shall not exceed the dimensions shown in Figure 3, Section X-X.

G. Insulation Barrel Crimp

The insulation barrel shall grip the insulation firmly. A slight cut in the insulation by the insulation barrel is permissible as this causes no problems in actual use. Insulation crimp shall comply to width and height provided in Figure 3.

H. Wire Location

The wire conductor and insulation must be visible in the transition area between the wire and insulation barrels.

I. Conductor Extension

The conductor may extend beyond the wire barrel to the maximum shown.

J. Wire Barrel Seam

The wire barrel seam must be closed with no evidence of loose wire strands visible in the seam.

i **NOTE**
 Periodic inspections must be made to ensure crimped contact formation is consistent as referenced.

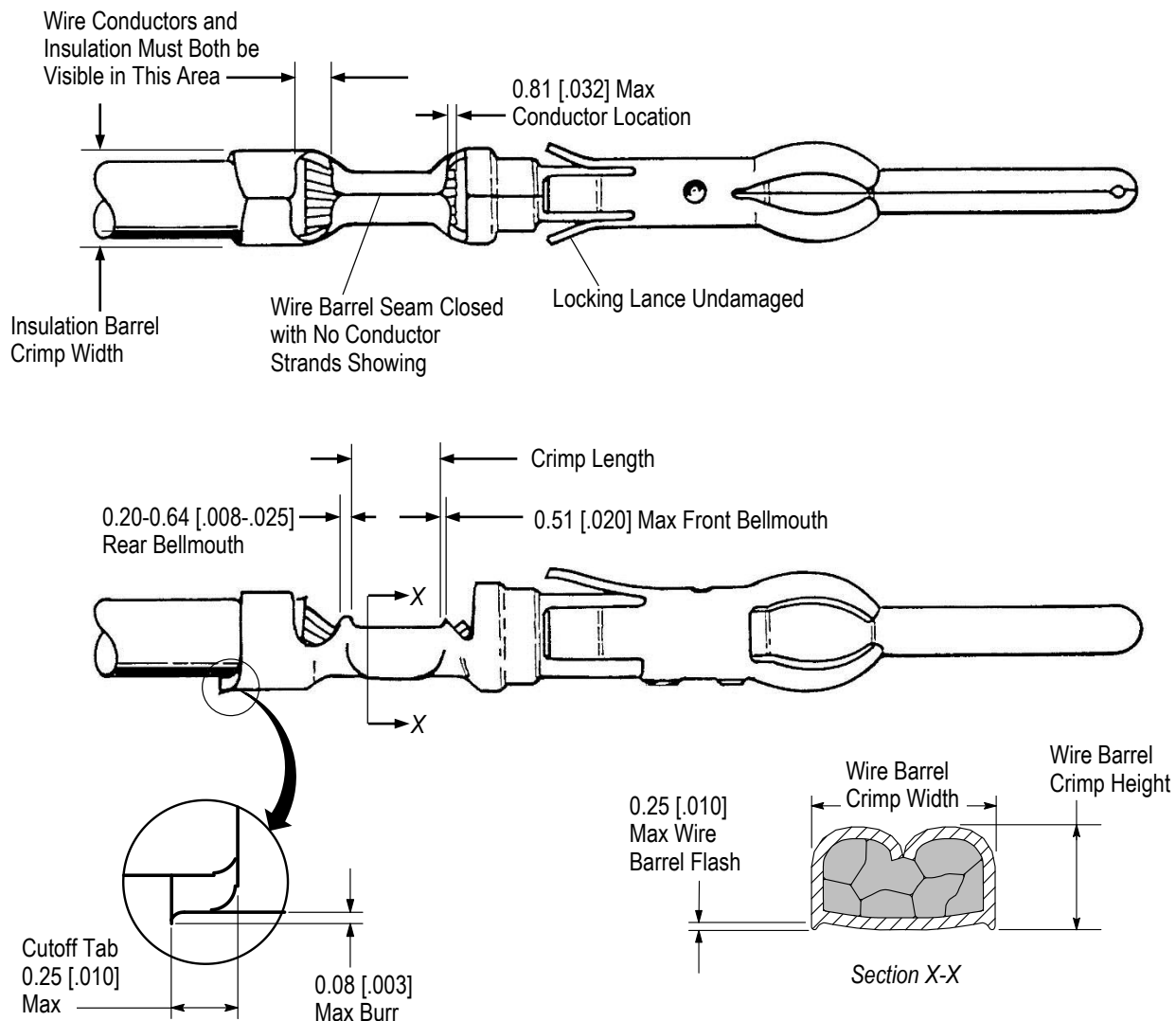

Figure 3

3.5. Axial Concentricity

The axial concentricity of a crimped contact must be within an area defined by the diameter of a circle that has the same center as the centerline of the contact. The diameter of the circle will depend on the wire sizes. See Figure 4. This measurement does not apply to posted contacts.

WIRE SIZE (AWG)	CIRCLE DIAMETER
30-28	3.40 [.134]
26-20	3.40 [.134]
18-14	4.16 [.164]

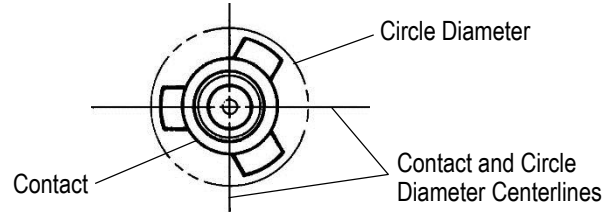

Figure 4

3.6. Posted Sockets

The posted sockets accept TERMI-POINT* Connectors or wrap-type terminations. They can accommodate up to three terminations per post. For terminating requirements, follow the instructions pertaining to specific choice of termination method and tooling types used.

3.7. Solder Tab Pin and Sockets

Observe all guidelines and procedures when solder type contacts are required. Solder, clean, and dry all wire leads to the contacts according to the following:

A. Flux Selection

The wire lead and contact wire barrel interior shall be fluxed prior to soldering using a mildly active rosin. Selection of the proper flux will depend on the type of pc board and other components mounted on the board. Additionally, the flux will have to be compatible with the wave solder line, manufacturing, and safety requirements.

B. Cleaning

After soldering, removal of fluxes, residues, and activators is necessary. Consult with the supplier of the solder and flux for recommended cleaning solvents. The following is a list of common cleaners that will not affect the connectors for the times and temperatures shown. See Figure 5.



DANGER

Consideration must be given to toxicity and other safety and health requirements as recommended in the Material Safety Data Sheet supplied by the solder cleaner solvent manufacturer.

CLEANER		TIME (Minutes)	TEMPERATURE (Max)
NAME	TYPE		
ALPHA 2110	Aqueous	1	132°C [270°F]
BIOACT EC-7	Solvent	5	100°C [212°F]
Butyl CARBITOL	Solvent	1	Ambient Room
Isopropyl Alcohol	Solvent	5	100°C [212°F]
KESTER 5778	Aqueous		
KESTER 5779	Aqueous		
LONCOTERGE 520	Aqueous		
LONCOTERGE 530	Aqueous		
Terpene	Solvent		

Figure 5

C. Drying

When drying cleaned assemblies and pc boards, make certain that temperature limitations of -55° to 105°C [-67° to 222°F] are not exceeded. Excessive temperatures may cause housing degradation.

D. Soldering Guideline

ALPHA, BIOACT, CARBITOL, LONCOTERGE, and KESTER are trademarks of their respective owners.

Refer to Paragraph 2.4, Manuals, for information on soldering requirements.

3.8. Repair/Replace

Contacts are not repairable once a termination has been made. Any defective or damaged contact must be removed and replaced with a new one.

Use Extraction Tool 305183 to remove individual contacts from housings for replacement or for relocation to another housing cavity.

4. QUALIFICATION

No qualifications or approvals are required for Type III+ Contacts.

5. TOOLING

These contacts can be terminated to wire using hand, semi-automatic, or automatic crimping tools. Recommended tooling is provided in Figure 6.

i **NOTE**
TE Tooling Engineers have designed machines for a variety of application requirements. For assistance in setting up prototype and production line equipment, contact TE Tool Engineering through your local TE Representative or call the Tooling Assistance Center number at the bottom of page 1.

- **Hand Crimping Tool**

Hand crimping tools that accommodate the full wire size range are designed for prototype and low-volume applications such as repair of damaged contacts.

- **Applicator**

Applicators are designed for the full wire size range of strip-fed, precision formed contacts, and provide for high volume, heavy duty, production requirements. The applicators can be used in bench or floor model power units.

i **NOTE**
Each applicator is shipped with a metal identification tag attached. DO NOT remove this tag or disregard the information on it. Also, a packet of associated paperwork is included in each applicator shipment. This information should be read before using the applicator; then it should be stored in a clean, dry area near the applicator for future reference. Some changes may have to be made to the applicators to run in all related power units. Contact the Tooling Assistance Center number located at the bottom of page 1 for specific changes.

- **Power Units**

A power unit is an automatic or semi-automatic device used to assist in the application of a product. Power unit includes the power source used to supply the force or power to an applicator.

- **Insertion/Extraction Tooling**

Insertion Tools are designed for contacts crimped to small fragile wire. They are designed to stabilize the contact during insertion. For use of Insertion Tool 91002 which may be used with these contacts, refer to Instruction Sheet 408-7347. Extraction Tools are designed to release the locking lance inside the connector housing without damaging the housing or contacts. For use of Extraction Tool 305183 which may be used with these contacts, refer to Instruction Sheet 408-1216.

WIRE SIZE RANGE (AWG)	INSULATION DIAMETER RANGE	HAND TOOL (408-8547)	APPLICATOR (DOCUMENT)	POWER UNIT (DOCUMENT)
30-26	1.02-1.52 [.040-.060]	91515-1	466598-2 (408-8040)	1725950-3 (409-32034) 2217000-1 (409-32035)
	0.36-0.76 [.014-.030]	(N/A)	2151847-[] (408-10389)	Contact TE
26-24	0.89-1.40 [.035-.055]	91515-1	2266335-[] (408-10389)	Contact TE
			466908-2 (408-8040)	1320895-1 (409-10012)

Figure 6 (cont'd)

WIRE SIZE RANGE (AWG)	INSULATION DIAMETER RANGE	HAND TOOL (408-8547)	APPLICATOR (DOCUMENT)	POWER UNIT (DOCUMENT)
24-20	102-203 [.040-.080]	91505-1 91515-1	2151016-[] (408-10389)	Contact TE
			466907-2 (408-8040)	1320895-1 (409-10012)
	2.03-2.54 [.080-.100]	91523-1	2151641-[] (408-10389)	Contact TE
			466942-1 (408-8040)	1320895-1 (409-10012)
	1.52-3.43 [.060-.135]	91542-1	466979-1 (N/A)	1320895-1 (409-10012)
			2151669-[] (408-10389)	Contact TE
18-16	2.03-2.54 [.080-.100]	91505-1 91515-1	2151023-[] (408-10389)	Contact TE
			466906-1 (408-8040)	1320895-1 (409-10012)
			466923-2 (408-8040)■	1320895-1 (409-10012)
18-14	2.03-2.54 [.080-.100]	91519-1	2151101-[] (408-10389)	Contact TE
	2.79-3.81 [.110-.150]	91521-1	2151405-[] (408-10389)	Contact TE
			466958-1 (408-8040)	1320895-1 (409-10012)
1 mm ²	1.45-1.80 [.057-.071]	Contact TE	2266714-[] (408-10389)	Contact TE
0.75 mm ²	1.35-1.65 [.053-.065]	Contact TE	2266714-[] (408-10389)	Contact TE

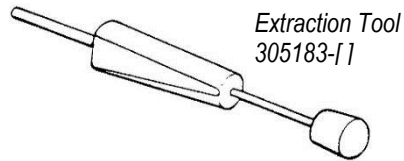
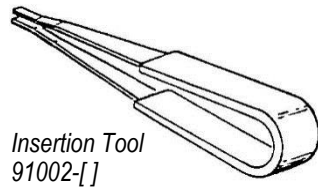

Typical Heavy Duty Mini (HDM) Applicator

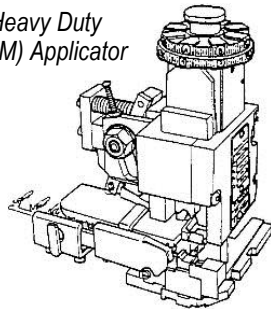

Typical Hand Tool

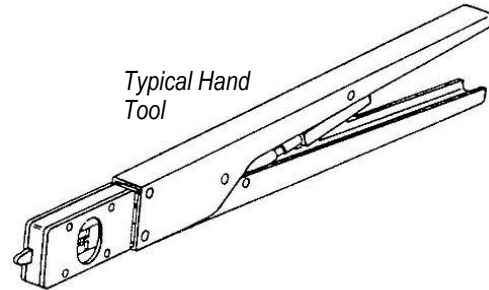

AMP-O-MATIC Side Feed Stripper-Crimper II Machine 1320895-[]

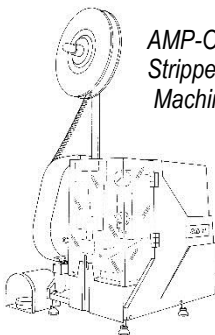

AMP 3K Terminating Machine 1725950-[]

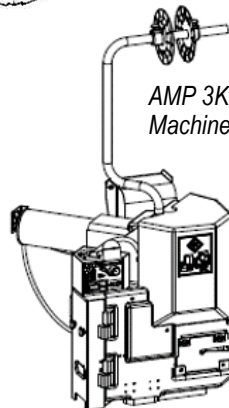

AMP-O-LECTRIC Model G II Terminator 2217000-[]



■ See Instruction Sheet (408-8039)

Figure 6 (cont'd)

6. VISUAL AID

The illustration below shows a typical application of this product. This illustration should be used by production personnel to ensure a correctly applied product. Applications which do not appear correct should be inspected using the information in the preceding pages of this specification and in the instructional material shipped with the product or tooling.

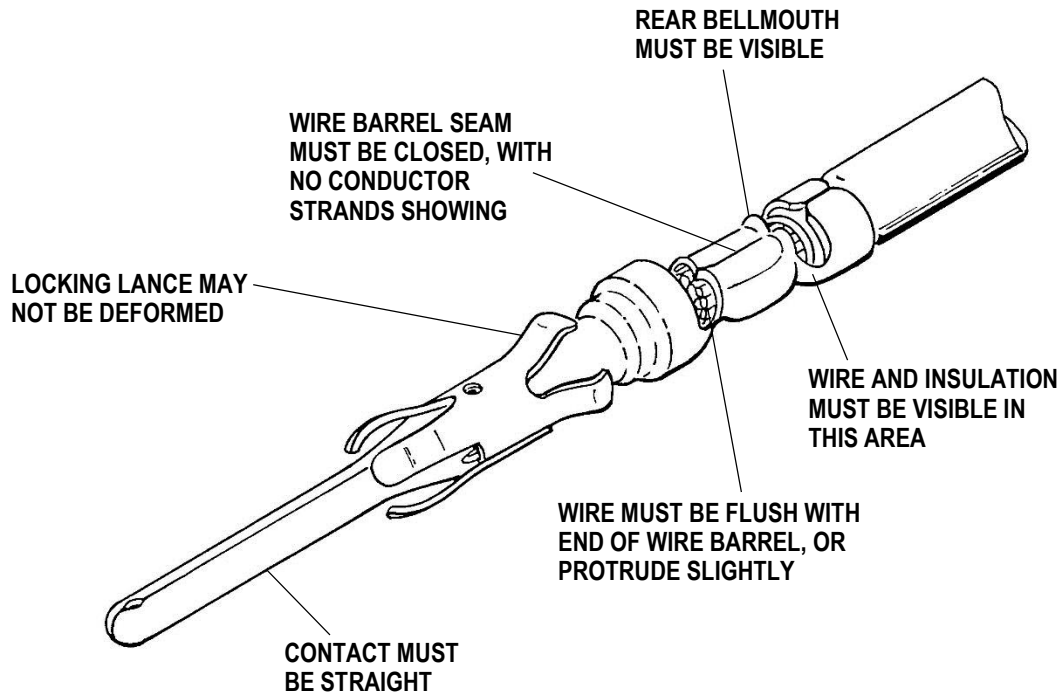

FIGURE 7. VISUAL AID