

NUMBER:
108-5300Customer
ReleaseSECURITY
CLASSIFICATION:

2. Applicable Documents :

The following documents form a part of this specification to the extent specified herein. In the event of conflict between the requirements of this specification and the product drawing, the product drawing shall take precedence. In the event of conflict between the requirements of this specification and the referenced documents, this specification shall take precedence.

2.1 AMP Specifications :

- A. 109-5000 Test Specification, General Requirements for Test Methods
 B. 114-5052 Application Specification, Crimping of 250 Series, Tab and Receptacle Contacts

2.2 Military Standard and Specifications :

MIL-STD-202 Test Methods for Electronic and Electrical Component Parts

2.3 Commercial Standards and Specifications :

- A. JIS C 3406 Low Voltage Cables for Automobiles.

3. Requirements :

3.1 Design and Construction :

Product shall be of the design, construction and physical dimensions specified in the applicable product drawing.

3.2 Materials :

- A. Contact : Brass, conforming to Alloy No. 260 of ASTM B36
 B. Housing :
 Cap Housing : 6/6 Nylon, Glass-filled,
 Plug Housing : 6/6 Nylon, Glass-filled, Heat Resistible Grade

3.3 Ratings :

- A. Voltage Rating : 100 VAC
 B. Current Rating : \longrightarrow
 C. Temperature Rating : -30°C to 105°C

3.3.1 Applicable PCB Thickness : 1.6 ± 0.15 mm

Wire Size		Rated Current (A)
mm ²	(AWG)	
0.3	(#22)	5
0.5	(#20)	8
0.85	(#18)	11
1.25	(#16)	15
2.0	(#14)	20
3.0	(#12)	25

SHEET

2 OF 9

AMPAMP (Japan), Ltd.
Kawasaki, JapanLOC
JLOC
A

NO.

108-5300

REV.
C

NAME

250 Series, 4-Position, Housing
Lance Connector for PCB

NUMBER : 108-5300

Customer Release

SECURITY CLASSIFICATION :

3.4 Performance and Test Descriptions :

The product is designed to meet the electrical, mechanical and environmental performance requirements specified in Fig. 2. All tests are performed at ambient temperature, unless otherwise specified.

3.5 Test Requirements and Procedures Summary :

Para.	Test Items	Requirements	Procedures					
3.5.1 (0)	Confirmation of Product	Product shall be conforming to the requirements of applicable product drawing and Application Specification 114-5052.	Visually, dimensionally and functionally inspected per applicable inspection plan.					
Electrical Performance Requirements								
3.5.1 (1)	Termination Resistance (Specified Current)	Wire Size		Test (A) Current	Millivolt Drop (mV)	Measure initial millivolt drop of contact test circuit in mated connectors, Fig. 4 . AMP Spec. 109-5305		
		mm ²	(AWG)					
		0.3	(#22)				2	6
		0.5	(#20)				4	12
		0.85	(#18)				7	21
		1.25	(#16)				10	30
		2.0	(#14)				15	45
3.0	(#12)	20	60					
3.5.1 (2)	Termination Resistance (Low Level)	10 mΩ max. (Final).	Subject contact-loaded and mated connector to open circuit voltage of 50 mA max. closed circuit current of 50 mA DC max. AMP Spec. 109-5306					
3.5.1 (3)	Dielectric Strength	Connector must withstand test potential of 1 kVAC for 1 minute. No abnormalities such as corona or flashover shall take place.	Measure by applying test potential between the adjacent contacts, and between the contacts and ground in the mated connectors. MIL-STD-202, Method 301					
3.5.1 (4)	Insulation Resistance	100 MΩ min. (Initial).	Measure by applying test potential between the adjacent contacts, and between the contacts and ground in the unmated connector. MIL-STD-202, Method 302, Condition B					

Fig. 2 (to be continued)

SHEET

3 OF 9

AMP (Japan), Ltd.
Kawasaki, Japan

LOC J LOC A NO.

108-5300

REV. C

NAME

250 Series, 4-Position, Housing
Lance Connector for PCB

108-5300	NUMBER :	Customer	SECURITY CLASSIFICATION :	Release	Para.	Test Items	Requirements				Procedures
					3.5.1 (5)	Temperature Rising vs. Current	Wire Size		Test	Temperature	Measure temperature rising by energized current. Fig. 4 AMP Spec. 109-5310
mm ²	(AWG)	Current (A)	Rising (°C)								
0.3	(#22)	2	20								
0.5	(#20)	4	20								
0.85	(#18)	7	20								
1.25	(#16)	10	30								
2.0	(#14)	15	30								
3.0	(#12)	20	30								
Physical Performance Requirements											
3.5.2 (1)	Crimp Tensile Strength	Wire Size		Crimp Tensile (min.)		Apply an axial pull-off load to crimped wire of contact second on the tester at a rate of 100 mm (4.0") a minute. AMP Spec. 109-5205					
		mm ²	(AWG)	N	(kgf)						
		0.3	(#22)	59	(6)						
		0.5	(#20)	88	(9)						
		0.85	(#18)	127	(13)						
		1.25	(#16)	177	(18)						
		2.0	(#14)	265	(27)						
3.0	(#12)	343	(35)								
3.5.2 (2)	Contact Mating Force	4.9-34.3N(0.5-3.5 kgf) per contact				Measure the force required to mate the contact by operating at 100 mm a minute. AMP Spec. 109-5206					
3.5.2 (3)	Contact Unmating Force	4.9-34.3N(0.5-3.5 kgf) per contact				Measure the force to unmate the contacts by operating at 100 mm a minute. AMP Spec. 109-5206					
3.5.2 (4)	Contact Retention Force	59N (6kgf) min.				Apply an axial load to contact by operating at a rate of 100 mm a minute. AMP Spec. 109-30					

Fig. 2 (to be continued)

SHEET				AMP (Japan), Ltd. Kawasaki, Japan	
4 OF 9	LOC	LOC	NO	REV.	
	J	0	108-5300	C	
NAME					
250 Series, 4-Position, Housing Lance Connector for PCB					

Para.	Test Items	Requirements	Procedures
3.5.2 (5)	Connector Mating Force	147 (15kgf) max. (initial) (4-Position connector)	Measure the force required to mate connector by operating at 100 mm a minute. Record by using autograph. AMP Spec. 109-5206
3.5.2 (6)	Connector Unmating Force	29.4N(3kgf) min. (initial) (4-Position connector)	Measure the force required to unmate connector without locking latch by operating at 100 mm (4 in.) a minute. Record by using autograph.
3.5.2 (7)	Vibration Sinusoidal Low Frequency	No abnormalities such as breakage of connector shall not take place. Termination Resistance : 10mV/A max.	Subject mated connectors to 33 Hz, 44 m/s ² (4.5G) accelerated velocity; 200 hours changing the axes in every 50 hours of duration. See. Fig. 5.
3.5.2 (8)	Solderability	Tested area shall have solder coverage of 95% minimum, excepting sheared surfaces.	Subject contacts to solderability testing. After pretreating by immersion into non-active flux (Alpha-100 or equivalent), immerse in soldering tub at 230 ± 5 °C for 3 ± 0.5 seconds.
Environmental Performance Requirements			
3.5.3 (1)	Humidity, Steady State	Insulation Resistance (Final) 100 MΩ min. Termination Resistance (Low Level) (Final) 10 mΩ min. Dielectric requirements shall be met.	Subject mated connectors to steady state humidity at 60 ± 5 °C and 90-95% R. H. for 96 hours. Connector shall be free from dripping affection. MIL-STD-202, Method 103, Condition B

Fig.2 (to be continued)

SHEET 5 OF 9			AMP (Japan), Ltd. Kawasaki, Japan	
	LOC J	LOC 0	NO. 108-5300	REV. C
NAME 250 Series, 4-Position, Housing Lance Connector for PCB				

NUMBER:
108-5300Customer
ReleaseSECURITY
CLASSIFICATION:

108-5300

NUMBER:

Customer
ReleaseSECURITY
CLASSIFICATION:

Para.	Test Items	Requirements	Procedures
3.5.3 (2)	Temperature Life	Termination Resistance (Low Level) (Final) : 10 mΩ max.	Subject mated connectors to exposure at 120 ± 3 °C for 120 hours, and recondition in the room temperature for 1 hour before subsequent measurement.
3.5.3 (3)	Resistance to Cold	Termination-Resistance (Low Level) : 10 mΩ max.	Subject mated connector to exposure under cold atmosphere at -50 °C for 120 hours. Recondition in the room temperature for 1 hour before subsequent measurement.

Fig.2 (end)

SHEET 6 OF 9			AMP (Japan), Ltd. Kawasaki, Japan	
	LOC J	LOC 0	NO. 108-5300	REV. C
NAME 250 Series, 4-Position, Housing Lance Connector for PCB				

3.6 Product Qualification and Requalification Tests

NUMBER: 108-5300
 Customer Release
 SECURITY CLASSIFICATION:

Test of Examination	Test Group										
	1	2	3	4	5	6	7	8	9	10	11
	Test Sequence (a)										
Examination of Product	1,4	1,4	1,3	1	1	1	1	1,4	1,6	1,5	1,4
Termination Resistance , Specified Current	2							3			
Termination Resistance , Dry Circuit									5	2,4	3
Dielectric Withstanding Voltage		3							4		
Insulation Resistance		2							3		
Temperature Rise vs Current	3										
Vibration								2			
Mating Force							2				
Unmaking Force							3				
Contact Retention						2					
Contact Engaging Force					2						
Contact Separating Force					3						
Crimp Tensile				2							
Solderability			2								
Humidity, Steady State									2		
Temperature Life										3	
Resistance to Cold											2

(a) Numbers indicate the sequence in which tests are performed.

Fig. 3

SHEET 7 OF 9			AMP (Japan), Ltd. Kawasaki, Japan	
			LOC J	LOC 0
NAME 250 Series, 4-Position, Housing Lance Connector for PCB				

108-5300

NUMBER :

Customer Release

SECURITY CLASSIFICATION :

4. Quality Assurance Provisions

4.1 Qualification Testing

A. Sample Selection

Connector housings and contacts shall be prepared in accordance with applicable Instruction Sheets and Application Specification, 114-5052. They shall be selected at random from current production. Unless otherwise specified, no sample shall be reused for testing.

B. Test Conditions :

Unless otherwise specified, all the test shall be performed under any combination of the following test conditions.

Temperature : 15 - 35 °C

Relative Humidity : 45 - 75 %

Atmospheric Pressure : 86.7 - 107 kPa (650 - 800 mmHg)

SHEET 8 OF 9			AMP (Japan), Ltd. Kawasaki, Japan	
	LOC J	LOC 0	NO. 108-5300	REV. C
NAME 250 Series, 4-Position, Housing Lance Connector for PCB				

NUMBER: 108-5300

NUMBER:

Customer Release

SECURITY CLASSIFICATION:

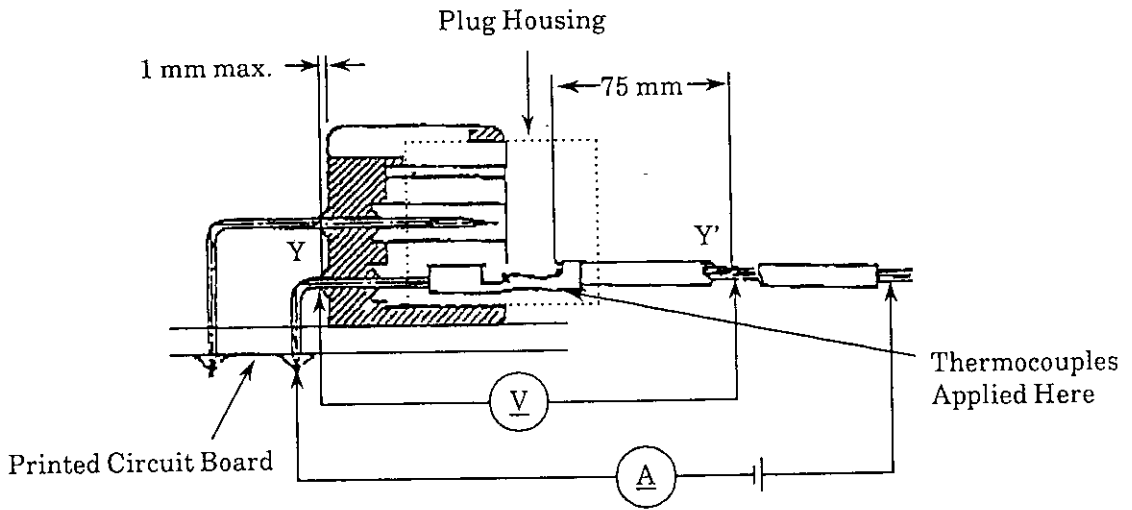

Fig. 3
Termination Resistance (Specified Current and Low Level) and Temperature Rising Measuring Method

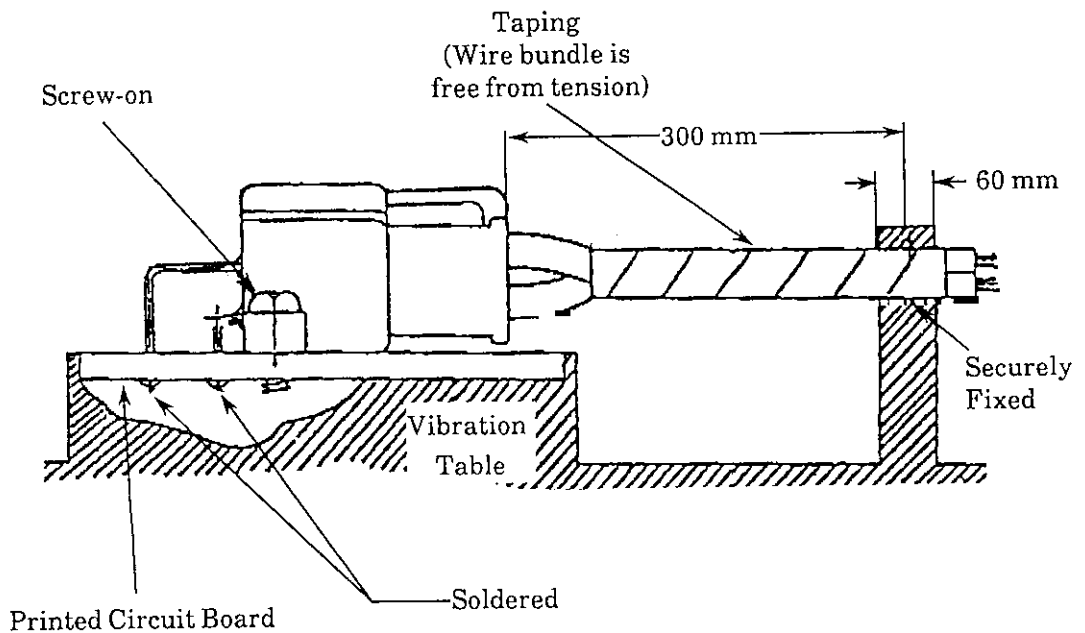

Fig. 4
Vibration Testing Method

SHEET 9 OF 9	AMP		AMP (Japan), Ltd. Kawasaki, Japan	
	LOC J	LOC 0	NO. 108-5300	REV. C
NAME 250 Series, 4-Position, Housing Lance Connector for PCB				