

Figure 1

1. INTRODUCTION

PRO BEAM Jr. EB low-profile D-Hole bulkhead connectors are designed to be installed onto 900- μm buffered fiber of a length less than 2 meters for use in transceiver connection.

NOTE



Dimensions in this instruction sheet are in metric units. Figures are not drawn to scale.

The connector must be assembled using a bulkhead connector shell kit, an EB insert assembly kit, and ferrule assembly kit (one for each fiber or channel). Sample part numbers are given in Figure 1. The combination of the kits selected is based on the diameter of the cable, the mode and quantity of fibers, and the operating wavelength of the system.

CAUTION



To avoid poor optical performance or permanent damage to the lens of the EB insert, use ONLY TE Connectivity ferrule assembly kits. Other manufacturers' ferrule assemblies ARE NOT compatible with the EB insert assembly kit.

These connectors are designed to be rear-panel mounted.

Reasons for reissue of this instruction sheet are provided in Section 7, REVISION SUMMARY.

2. DESCRIPTION

Each kit contains the components shown in Figure 1.

The EB insert assembly kit is shipped with a white protective label on the back (end opposite the lens) of the EB insert. It is installed immediately after final testing to keep the channel cavities clean. The EB insert is ready for assembly as shipped.

3. HANDLING

DANGER



To avoid personal injury, NEVER look into the end of terminated or unterminated optical fibers. Laser radiation is invisible but can damage eye tissue.

- Do not touch the lens of the EB insert with your fingers or with any tools

NOTE



If the lens is touched or otherwise contaminated, clean the lens according to Instruction Sheet 408-8828.

- Always have the protective cap installed or the connector mated to prevent contamination to the EB insert assembly

4. TOOLS AND MATERIALS

The following tools and materials are necessary for preparation, assembly, inspection, and maintenance of the connector and fibers. Follow the operating instructions packaged with the tools and safety guidelines packaged with the materials.



Items without a part number or supplier are customer supplied.

4.1. Tools

- environmental test oven
- Heat Cure Oven Assembly 502134-1 (120 Vac) or 502134-2 (240 Vac), includes universal heat cure block (408-9460)
- Fiber Stripping Tool 1278947-1 (408-4577)
- Fiber Jacket Stripper 1278531-1
- Curing Fixture 1754122-1 (408-8857)
- Sapphire Scribe Tool 504064-1 (408-4293)
- polishing machine (recommended) or Polishing Bushing 503337-1 (for hand polishing)
- 200x Microscope Kit 1754767-1
- Ferrule Insertion Tool 1693820-1
- needle-nose pliers
- 2.5-mm hex wrench
- EB Insert Assembly Fixture 1515844-1
- Housing Key 1515831-1
- 20-mm open-end wrench

4.2. Materials

- Buffer Protective Tubing 492667-1 (bulk reel)
- EPO-TEK 353ND-T epoxy
- Epoxy Applicator Kit 501473-3
- Lint-free tissues or cloths
- isopropyl alcohol (99%) or acetone

For hand polishing only:

- 5- μ m Aluminum Oxide Polishing Film 228433-8
- 1mm Rubber Polishing Pad 501858-1 (green)
- 0.3- μ m Diamond Polishing Film 228433-5
- Final Polishing Film 502748-2
- Lint-free applicator swabs
- Dow Corning Molykote 55 O-ring grease
- Loctite 243 Medium Strength Threadlocker

5. ASSEMBLY PROCEDURE

IMPORTANT: Assemble the connector using a laminar flow table in a clean environment meeting the requirements of International Organization for Standardization (ISO) 14644-1 (Class 5), “Cleanrooms and Associated Controlled Environments, Part 1.” Make sure that all components are free from contamination.

Proceed as follows:

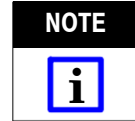

These instructions are for single-channel connectors. For multi-channel connectors, perform the same assembly procedure for each channel.

5.1. Prepare and Terminate the Fiber

1. If the protective tubing *is not* installed onto the buffered fiber, proceed with the following:

- a. Pre-heat the environmental test oven to a temperature between 100°C and 105°C.
- b. Cut the protective tubing to a length of approximately 10% longer than the length of the buffered fiber.
- c. Stress-relieve the protective tubing by placing it in the environmental test oven for 45 to 60 minutes.



The protective tubing must be stress-relieved; otherwise, it may shrink during application and cause the fiber to buckle.

d. Slide the prepared protective tubing over the buffered fiber, allowing approximately 100 mm of the buffered fiber to be exposed.

e. Pre-heat the heat cure oven to 100°C.

f. Slide the components shown in Figure 2 over the buffered fiber and onto the protective tubing. Make sure to orient each component as shown.

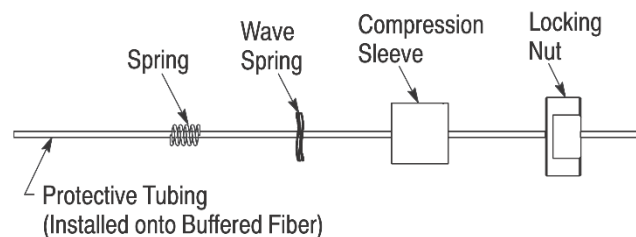

Figure 2

Loctite and 243 are trademarks of Henkel Corporation.

Dow Corning and Molykote are registered trademarks of Dow Corning Corporation.

g. Using the fiber stripping tool, strip the buffered fiber to the dimension shown in Figure 3, exposing the bare fiber. Using a lint-free tissue or cloth dampened with the isopropyl alcohol or acetone, clean the bare fiber.

h. Prepare the ferrule assembly according to Paragraph 5.2.

i. Carefully insert the bare fiber into the back of the ferrule assembly. Simultaneously slide and rotate the ferrule assembly on the fiber (to prevent any air pockets from being trapped in the epoxy) until it bottoms. Make sure that the bare fiber is protruding from the end face of the ferrule assembly. If it is not, re-strip the fiber.

j. Apply a *thin film* of epoxy around the outside edge of the protective tubing to the width given in Figure 3.

k. Insert the protective tubing into the back of the ferrule assembly until the tubing bottoms.

l. Proceed to Step 3.

2. If the protective tubing is installed (and secured) onto the buffered fiber, proceed with the following:



MAKE SURE THAT THE PROTECTIVE TUBING IS STRESS-RELIEVED; otherwise, it could shrink during application and cause the fiber to buckle.

a. Pre-heat the heat cure oven to 100°C.

b. Slide the components shown in Figure 2 onto the protective tubing, allowing 23±1 mm at the end of the tubing for stripping. Make sure to orient each component as shown.

c. Mark the protective tubing to the dimension shown in Figure 4. Using Slot 22 of the fiber jacket stripper, strip the tubing to the marking.

d. Using the fiber stripping tool, strip the buffered fiber to the dimension shown in Figure 4, exposing the bare fiber. Using a lint-free tissue or cloth dampened with the isopropyl alcohol or acetone, clean the bare fiber.

e. Prepare the ferrule assembly according to Paragraph 5.2.

f. Apply a *thin film* of epoxy around the outside edge of the tubing to the width given in Figure 4.

g. Carefully insert the bare fiber and protective tubing into the back of the ferrule assembly. Simultaneously slide and rotate the ferrule assembly on the fiber (to prevent any air pockets from being trapped in the epoxy) until it bottoms. Make sure that the tubing enters

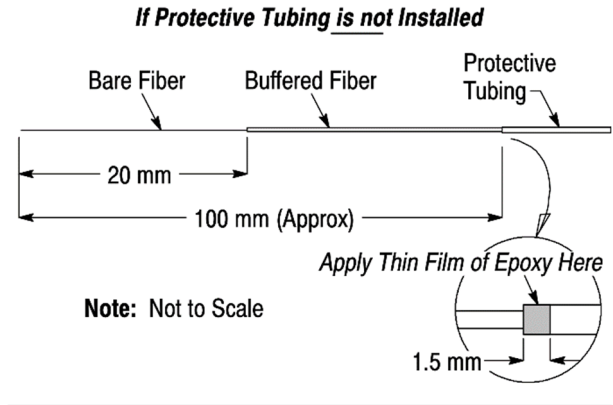

Figure 3

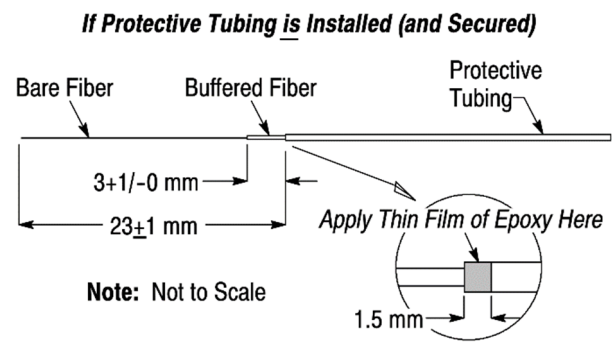

Figure 4

and adheres to the base. Make sure that the bare fiber is protruding from the end face of the ferrule assembly. If it is not, re-strip the fiber.

h. Proceed to Step 3.

3. Place the assembly in the curing fixture according to the instructions included with the curing fixture.

4. Cure the assembly in the heat cure oven at 100°C for 20 minutes. Remove the assembly from the oven and allow the assembly to cool to room temperature.

5.2. Prepare the Ferrule Assembly

1. Prepare the epoxy according to the following:

a. Remove the separating clip from the epoxy package. Mix the two components together thoroughly for 20 to 30 seconds.

b. Install the needle tip on the applicator from the epoxy applicator kit. Make sure it is secure. Remove the plunger.

c. Cut the epoxy packet open and squeeze the epoxy into the back of the applicator. Re-assemble the plunger. Hold the applicator vertically, and slowly push on the plunger until the entrapped air escapes and a bead of epoxy appears at the needle tip.

d. Using a lint-free tissue or cloth dampened with the isopropyl alcohol or acetone, clean the tip of the applicator.

2. Hold the ferrule assembly vertically and insert the needle tip into the base of the ferrule assembly until it is against the back (end closest to the base) of the ferrule assembly. Refer to Figure 5.

3. While holding the ferrule assembly *firmly* against the needle tip, *slowly* inject the epoxy until a small bead of epoxy (approximately 0.75 mm in diameter) forms at the end face of the ferrule assembly. DO NOT allow the bead to get too large or smear.

4. Withdraw the needle slightly (approximately 2 to 3 mm) and inject an additional small amount of epoxy so that the cavity at the base of the ferrule assembly is no more than one-third full.

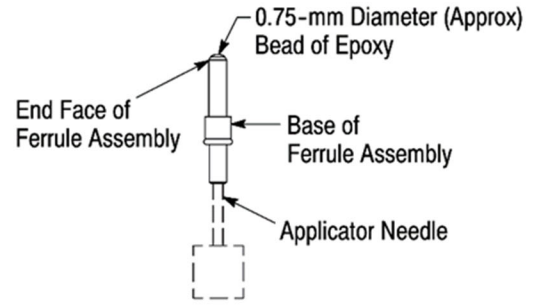

Figure 5



CAUTION Make sure the cavity is no more than one-third full. Excess epoxy at the base of the ferrule assembly will wick into the protective tubing and cause the fiber to break during use.



DANGER To avoid personal injury, remember that epoxy is a hazardous material, and pay particular attention to the following:

- ALWAYS follow manufacturer's safety guidelines.
- ALWAYS wear protective gloves when using epoxy.
- ALWAYS use epoxy in a well-ventilated area.
- AVOID prolonged and frequent contact with skin.
- AVOID inhaling fumes from epoxy.

5.3. Cleave the Fiber

Firmly support the ferrule assembly and draw the beveled edge of the scribe tool across the fiber as shown in Figure 6. After scoring the fiber, pull the fiber straight away from the ferrule assembly.



DANGER Safely dispose of excess fiber.



CAUTION To avoid damage to the tip of the scribe tool, DO NOT allow the scribe tool to contact the epoxy.

After Scoring, Pull Fiber Straight Away

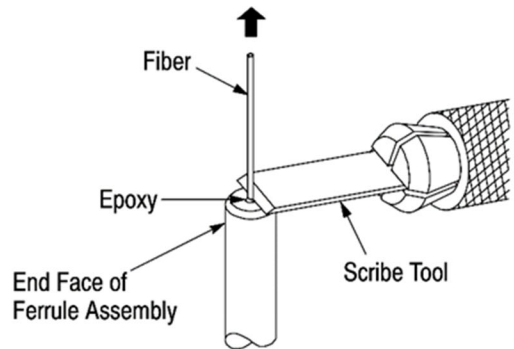

Figure 6

5.4. Polish the Fiber

It is recommended polishing the fibers using a polishing machine. Machine polishing will usually produce the best results. Polish the fibers according to the machine manufacturer's instructions. For best performance, as a minimum the polish should be an SPC (super physical contact) end finish for multimode, and a UPC (ultra physical contact) end finish for singlemode.

If machine polishing is not possible, hand polish the fiber according to the following:

1. Using a small piece of the 5- μ m polishing film, remove the fiber stub to the level of the epoxy.
2. Install the ferrule assembly onto the polishing bushing.
3. Place the green polishing pad on a hard, flat surface. Place the 5- μ m polishing film on the polishing pad.

4. Hold the ferrule assembly and rest the tips of your index finger, middle finger, and thumb on the top of the polishing bushing. Starting with very light pressure, polish the tip of the fiber in a figure-8 pattern. Refer to Figure 7. Polish the fiber until the epoxy turns a very light yellow.

NOTE



DO NOT remove all the epoxy. As the epoxy gets lighter, check the tip of the fiber frequently.

5. Clean the end face of the ferrule assembly and polishing bushing with isopropyl alcohol or acetone and a lint-free tissue.

6. Place the 0.3- μ m polishing film on the polishing pad. Polish in a figure-8 pattern. Stop polishing as soon as all the epoxy is removed.

7. Clean the end face of the ferrule assembly and polishing bushing with isopropyl alcohol or acetone and a lint-free tissue.

8. Place the final polishing film on the polishing pad. Apply several drops of water to an unused area of the film. Move the ferrule assembly in 20-mm circles on the water for 25 seconds.

NOTE



One sheet of final polishing film will be enough for 10 to 20 ferrule assemblies.

9. Remove the ferrule assembly from the polishing bushing. Clean the end face and sides of the ferrule assembly with isopropyl alcohol or acetone and a lint-free tissue.

5.5. Inspect the Ferrule Assembly and Fiber

DANGER



Never inspect or look into the end of a fiber when optical power is applied to the fiber. The infrared light used, although it cannot be seen, can cause injury to the eyes.

1. Using the microscope, inspect the ferrule assembly and fiber according to the following criteria (refer to Figure 8):

- Make sure that any epoxy is removed from the ferrule assembly
- Dirt may be mistaken for small pits. If dirt is evident on the ferrule assembly or fiber, clean with isopropyl alcohol or acetone and a lint-free tissue, then dry
- Fine polishing lines are acceptable
- Small peripheral chips (at the outer rim) on the fiber are acceptable

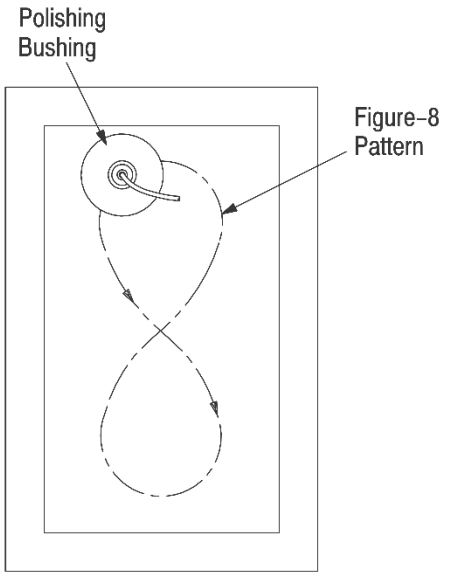

Figure 7

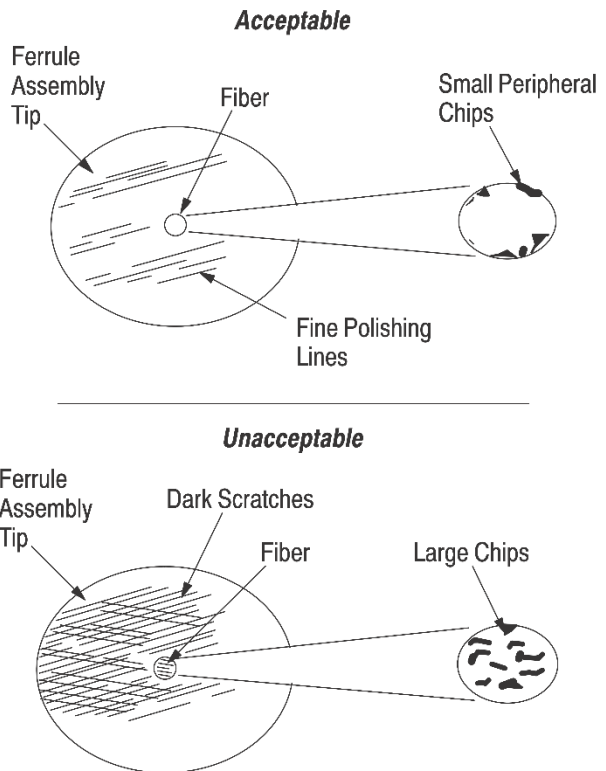

Figure 8

— Large chips in the center of the fiber and dark scratches are unacceptable, and the fiber must be re-terminated.

2. If necessary, install the dust cover onto ferrule assembly to prevent contamination to the end face.

5.6. Complete the Assembly

1. Remove the protective label from the back (end opposite the lens) of the EB insert.
2. Slide the spring onto the end of the ferrule assembly. See Figure 9, Detail A.
3. Align the end of the ferrule assembly with the appropriate channel cavity of the EB insert and insert the ferrule assembly into the channel cavity until the O-ring is against the channel cavity. See Figure 9, Detail B. To avoid damage to the fiber, **DO NOT** push on the fiber to install the ferrule assembly.

IMPORTANT: The channels for each fiber pair are designated on the EB insert with "A1" and "B1," and "A2" and "B2." For proper end-to-end system connection, connect A1 to B1, B1 to A1, A2 to B2, and B2 to A2.

4. Using the ferrule insertion tool, **push on the spring** until the ferrule assembly bottoms in the channel cavity (the O-ring will be inside of the cavity, and the spring will protrude slightly from the cavity). See Figure 9, Detail B.

NOTE  If necessary to remove the ferrule assembly from the cavity, firmly grasp the end of the ferrule assembly (but not the spring) with the needle-nose pliers, and pull it out of the cavity.

CAUTION  To avoid damage to the fiber, **DO NOT PUSH OR PULL ON THE FIBER** to install or remove the ferrule assembly from the cavity.

5. Align the index pin hole of the ferrule plate with the index pin at the back of the EB insert and slip the fiber into the closest slotted hole in the ferrule plate. See Figure 9, Detail C.

6. Hold the ferrule plate against the EB insert, making sure that the index pin enters the index hole. Thread the screw through the screw hole of the ferrule plate and into the hole in the EB insert. See Figure 9, Detail D. Using the 2.5-mm hex wrench, tighten the screw to a torque between 0.8 and 1.0 N·m. Check to make sure that the ferrule plate is flush with the EB insert.

7. Align the guide pins with the guide holes and fit the EB insert assembly fixture onto the EB insert assembly. Refer to Figure 9, Detail E.

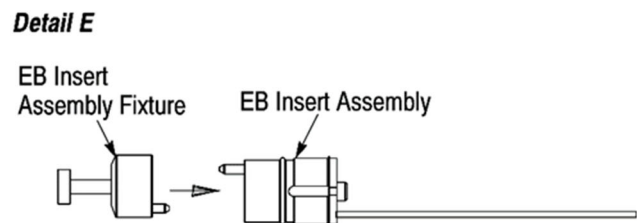
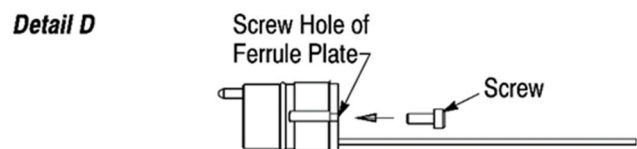
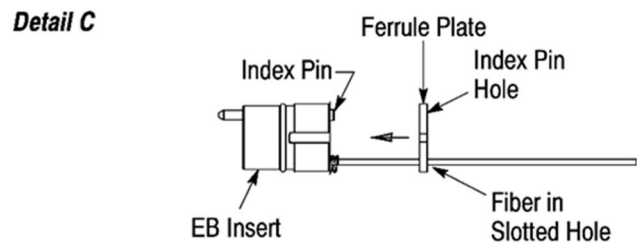
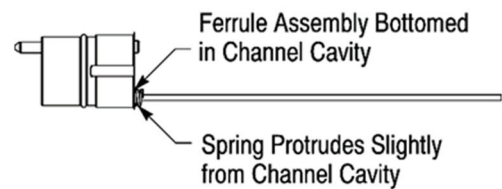
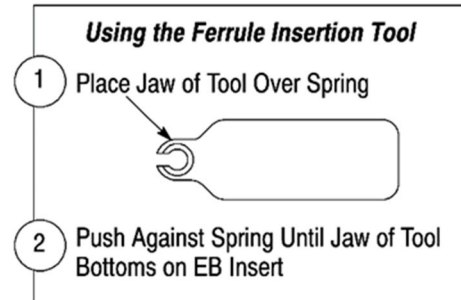
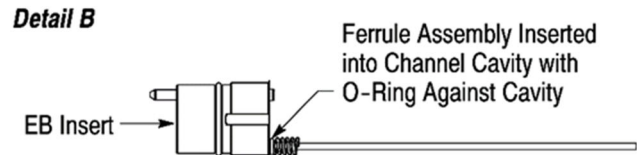
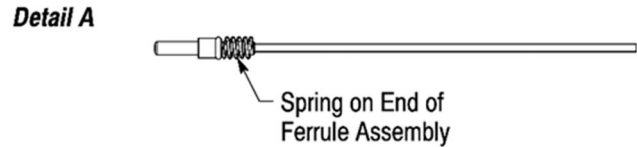

Figure 9

NOTE



Using the fixture will help guide the EB insert assembly into the housing and minimize the possibility of grease contaminating the face of the EB insert.

8. Using an applicator swab, apply a *thin film* of the grease around the O-ring on the outside of the EB insert, the front seal on the inside of the housing, and the internal O-ring of the D-hole housing. Remove any excess grease. Refer to Figure 10, Detail A.

CAUTION



To avoid contaminating optical components, **DO NOT** use heavy deposits of the grease.

9. Align the keyways (located inside) of the D-hole housing with the back end (opposite the front seal) of the housing so that the desired rotational orientation is established (use the flat on the D-hole housing as the reference point). Refer to Figure 10, Detail B. Then slide the D-hole housing onto the housing until it stops. The interference fit of the internal O-ring of the D-hole housing with the housing should prevent the D-hole housing and housing from separating during assembly.

NOTE



There are 4 rotational orientations for mounting the connector to the panel: top, bottom, left, or right. Aligning one of the keyways located inside the D-hole housing with one of the external keys of the housing will establish the rotational orientation (one keyway is parallel to the flat). Refer to Figure 10, Detail B.

10. Align the internal key (small bar inside) of the housing with the keyway (slot along the outside) of the EB insert, and slide the fixture along with the EB insert assembly into the housing. See Figure 10, Detail C.

11. Using the 2.5-mm hex wrench, push the EB insert into the housing until it bottoms. To avoid damage to the fiber, **DO NOT** push on the fiber to install the EB insert.

12. Remove the fixture from the front of the housing.

13. Slide the wave spring and compression sleeve into the housing. See Figure 10, Detail D.

14. Push-fit the housing key onto the housing. Using the T-handle to hold the connector, apply 2 or 3 drops of the threadlocker to the threads of the housing. See Figure 10, Detail E.

15. Slide the locking nut onto the housing, and finger-tighten. Using the 20-mm open-end wrench, tighten the locking nut to a torque between 10 and 12 N·m.

16. Remove the housing key.

Detail A

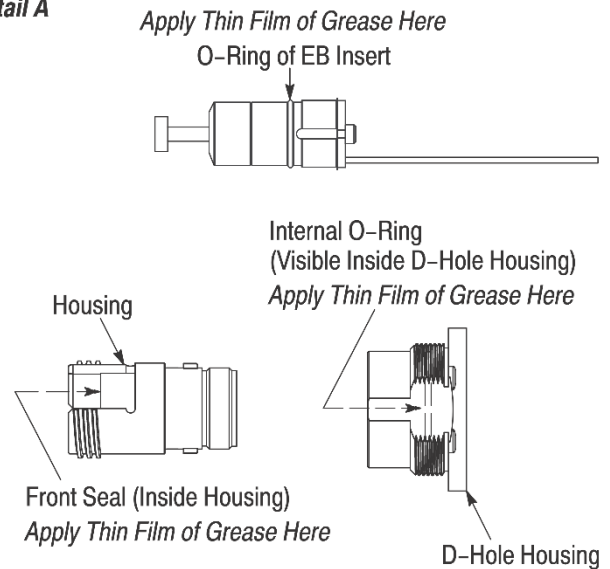

Detail B

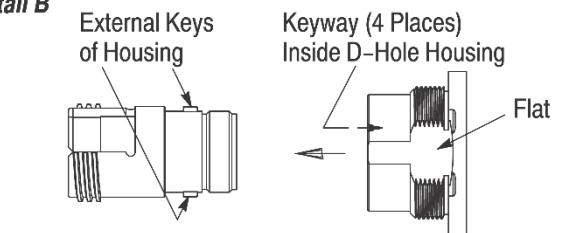

Detail C

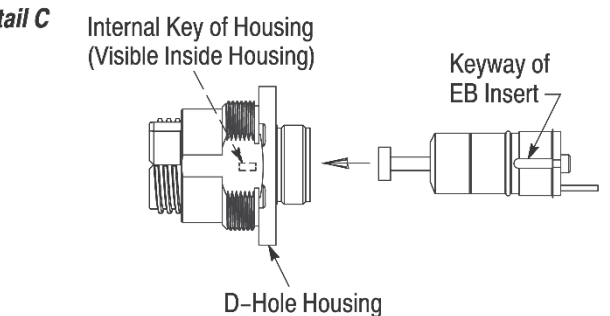

Detail D

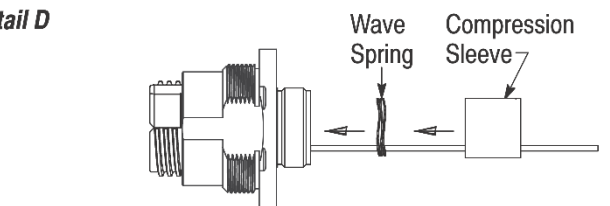

Detail E

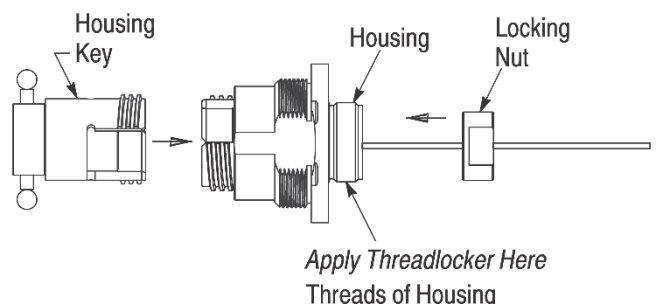

Figure 10

5.7. Mount the Connector onto the Panel and Install the Protective Cap

1. Cut the panel using the dimensions provided in Figure 11.

NOTE



Make sure that the flat edge is located in the position needed to match the established rotational orientation.

2. Install the connector through the back of the panel so that the O-ring on the shoulder of the D-hole housing is flat against the panel. See Figure 12, Detail A.

3. Thread the panel nut onto the D-hole housing. See Figure 12, Detail A. Tighten the panel nut to a torque of approximately 40 N·m. When the panel nut is secure, the O-ring should be compressed.

4. Thread the protective cap onto the housing, then hand-tighten the protective cap as shown in Figure 12, Detail B.

6. REPLACEMENT AND REPAIR

Kit components are not repairable. DO NOT use any damaged or defective components. DO NOT attempt to re-use the crimp support, crimp sleeve, or ferrule assembly by removing the fiber.

Order replacement parts through your TE Connectivity representative, or call 1-800-522-6752, or use the LIVE CHAT on the www.te.com website.

7. REVISION SUMMARY

Revisions to this instruction sheet include:

- Updated document to current corporate requirements
- Section 4.1: updated fiber stripping tool and polishing bushing p/n's, removed epoxy p/n and replaced with recommended epoxy brand and type, removed polishing plate
- Section 5.4: revised singlemode/multimode polish requirements and Steps 3, 6, and 8

Recommended Panel Cutout

Panel Thickness Range of 1- 6.5 mm

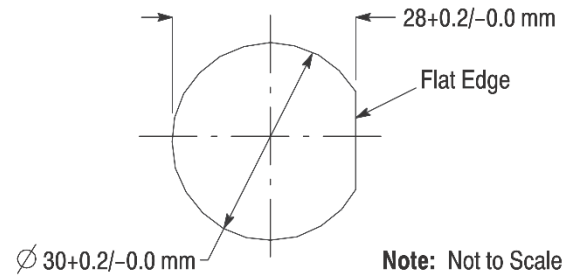
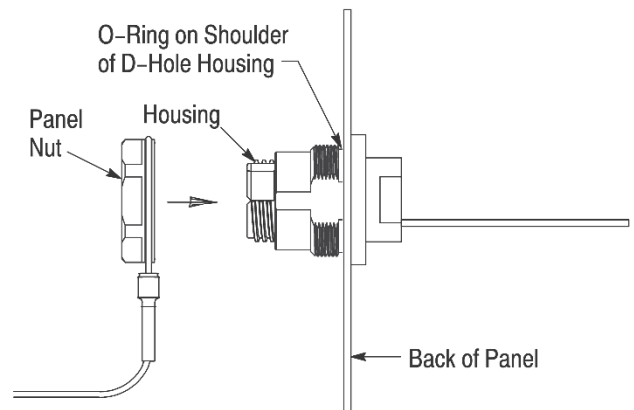

Figure 11

Detail A



Detail B

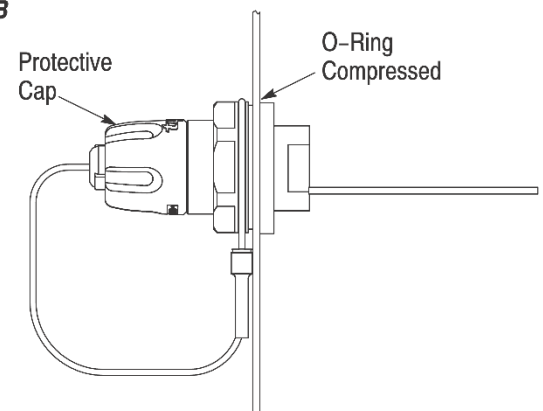

Figure 12