

# APPLICATION SPECIFICATION

## RECEPTACLE MIC MK II CONTACT FOR SINGLE WIRE SEALING

### SCOPE

This specification covers the requirements for application of **RECEPTACLE MIC MK II** Contact P/N **281938-1** and **281938-2** for single wire sealing

### GENERAL

These contacts are suitable for 0.5-2.5 mm<sup>2</sup> wire, with single wire seal.

Each wire is inserted into a discrete wire seal before to being crimped into the contact.

The insulation barrel is crimped so that the wire seal is gripped in order to avoid any movement of the seal.

The contacts are suitable for single wire only.

### 1. CRIMPING

The following information contains nomenclature, crimping conditions, crimp data for mini-applicators, insertion of wire seals on cables, mending or replacement of parts and checks.

THIS INFORMATION IS CONFIDENTIAL AND IS DISCLOSED TO YOU ON CONDITION THAT NO FURTHER DISCLOSURE IS MADE BY YOU TO OTHER THAN AMP PERSONNEL WITHOUT WRITTEN AUTHORIZATION FROM AMP ITALIA S.p.A.  
TEC 034 2.83

				DR S. SERRA 01-92		<b>AMP</b> AMP ITALIA S.p.A. Corso F.lli Cervi, 15 COLLEGNO (TORINO)		
				CHK S. Gai 11.02.98				
				APP.		LOC I	NO 114-20052	REV. A
				SHEET 1 OF 6		NAME APPLICATION SPECIFICATION FOR: (SPECIFICA DI APPLICAZIONE PER:) RECEPTACLE MIC MK II		
DIST. A	REV LTR	REVISION RECORD	DR A	DATE E.C.H.	3-3-92 1-3004			

## 1.1 NOMENCLATURE

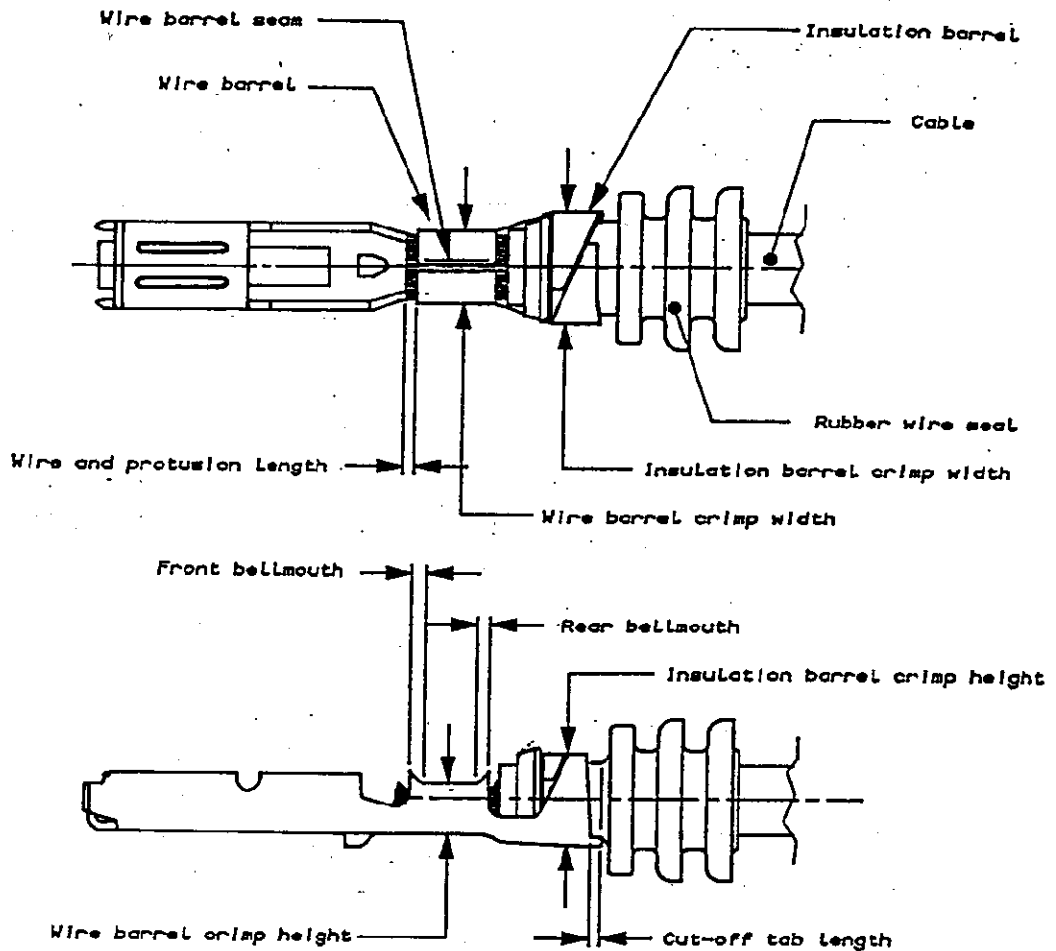

Fig. 1

## 2. CRIMPING CONDITIONS

Refer to nomenclature (Par. 1.1) see Fig. 1  
Fig. 2 and Fig. 3.

- |  |               |
|--|---------------|
| 1. Cut-off tab length                      | 0,3 mm max    |
| 2. Front bellmouth                         | not present   |
| Rear bellmouth                             | 0,35x60° min  |
| 3. Bend up                                 | 5° max        |
| Bend down                                  | 5° max        |
| Bend right                                 | 5° max        |
| Bend left                                  | 5° max        |
| Rolling                                    | 5° max        |
| 4. Cable end protrusion<br>(brush length)  | 0,2 to 0,8 mm |
| 5. Insulation stripping<br>length          | 4,5 to 5,0 mm |
| 6. Wire barrel seam must be neatly closed. |               |

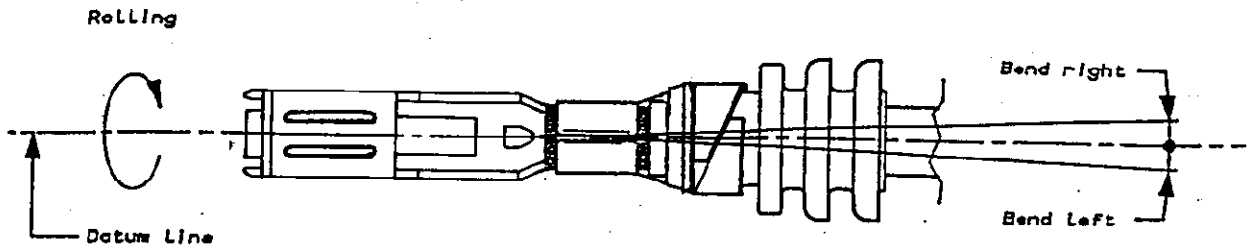

Fig. 2

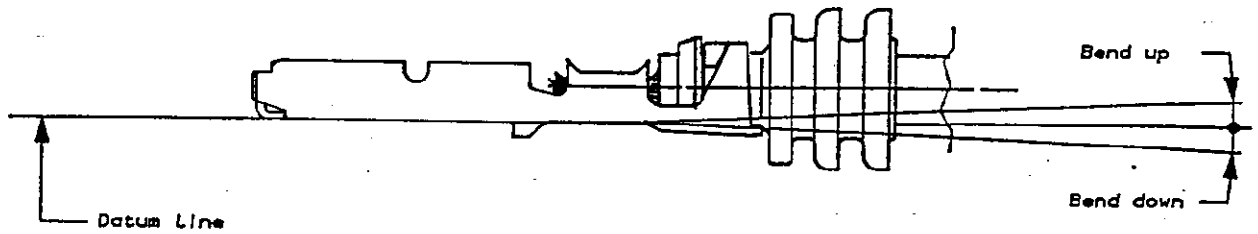

Fig. 3

3. CRIMP DATA

3.1 For applicator crimping see Fig. 7.

4. INSERTION OF RUBBER WIRE SEAL ON THE CABLE

When the rubber seal is installed on cable, the end of the cable insulation shall be positioned from the edge of the rubber seal, as shown in Fig. 4. This length is usually regardless of cable size.

NOTE: Seals are supplied lubricated. This lubrication must not be removed.

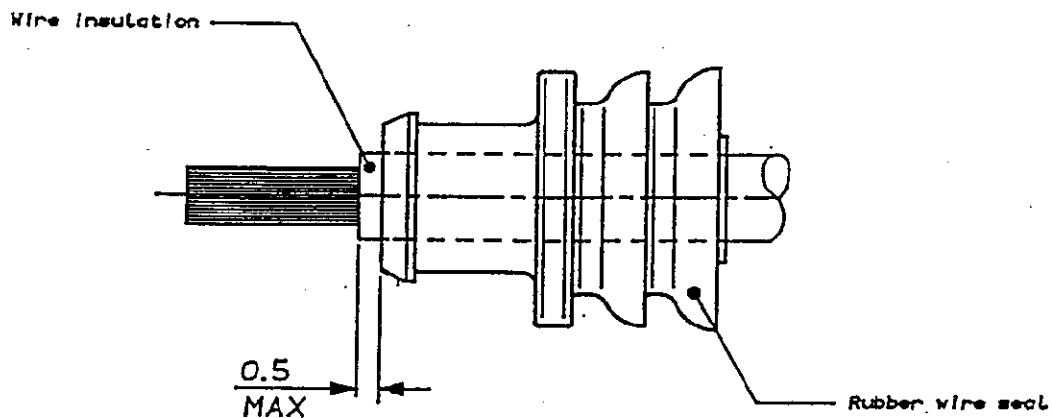

Fig. 4

IEC 035 2.83

**AMP**

AMP ITALIA S.p.A.  
Corso F.lli Cervi, 15  
COLLEGNO (TORINO)

LOC.  
**I**

SHEET  
3 OF 6

NO  
114-20052

REV.  
**A**

5. CORRECTION OR REPLACEMENT OF PARTS

When defects and/or improper applications are found on parts to be installed, as shown in Fig. 5, rework to set up properly, or replace with new part.

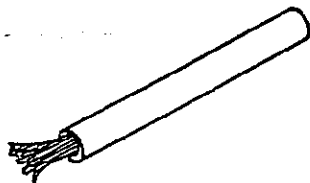

The end of the cut wire shall appear neat without any bend of stranded conductor

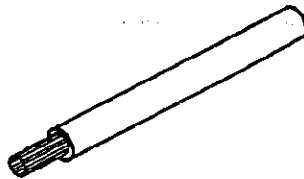

The conductor shall be free from nick, cut and scrape.

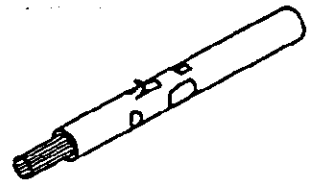

The wire insulation must have smooth surface in a round form without damage, groove or recessed surface.

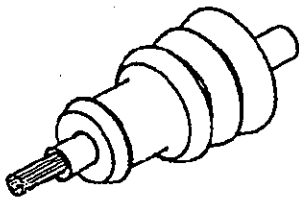

The end of the wire shall be straight without bend and untidiness after insertion of the wire seal. The bent wire seal be checked out

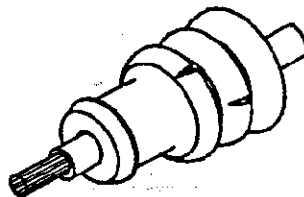

The flanges of the rubber seal shall be free from cut and damage. Any seal having such defects shall be discarded, and replaced with new part.

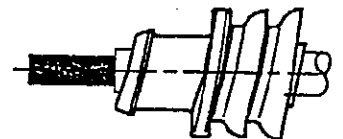

Insertion of rubber seal shall be done straighty and evenly. If flanges are in tilt condition, the plug must be corrected so that flanges are perpendicular to contact center line.

Fig. 5

TEC 035 2.83

**AMP**

AMP ITALIA S.p.A.  
Corso F.lli Cervi, 15  
COLLEGNO (TORINO)

LOC.

I

SHEET

4 OF 6

NO

114-20052

REV.

A

5.1 After crimping, the part of the cable insulation that is inside the seal shall be in good condition and within the requirements shown in Figure 5. Check by visual inspection in the transition area (between wire and insulation barrel), as indicated in Figure 6.

After crimping, the rubber seal must protrude from the insulation crimp without any damage.

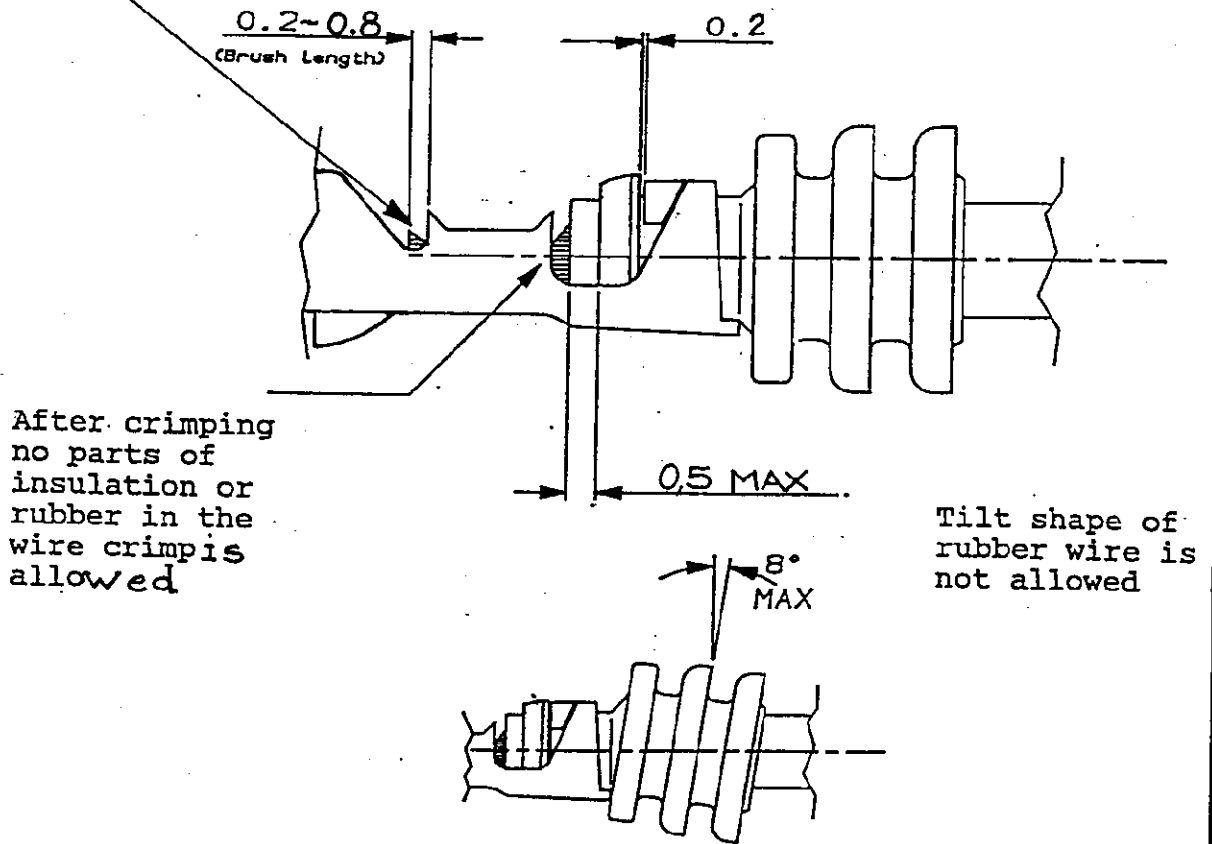

Fig. 6

5.2 Crimped contacts should appear as illustrated in Par. 1.1 (Nomenclature).

TEC 035 2.03

**AMP**

AMP ITALIA S.p.A.  
Corso F.lli Cervi, 15  
COLLEGNO (TORINO)

LOC.

I

SHEET

5 OF 6

NO

114-20052

REV.

A

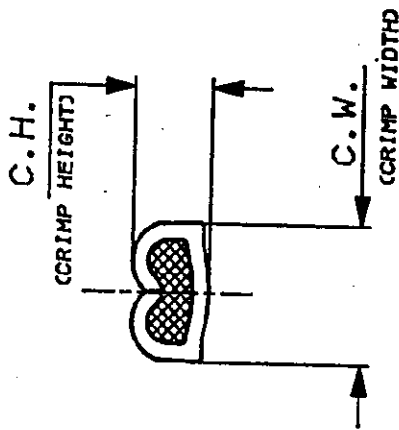

Fig. 7

(Dimensions are in mm)

PART. NO. TERMINAL	PART. No. RUBBER PLUG	WIRE SIZE mmq	(FASE-2) INS. DIA. MAX	STRIP LENGTH	WIRE BARREL CRIMP		INS. BARREL CRIMP		
					HEIGHT (REF)	WIDTH (REF)	TYPE	WIDTH (REF)	TYPE
281938-1	281934-2	0,5	1,90	4,5	1,29	2,54	*F*	4,19	*O*
281938-1	281934-2	0,75	2,30	4,5	1,40	2,54	*F*	4,19	*O*
281938-1	281934-2	1,0	2,30	4,5	1,47	2,54	*F*	4,19	*O*
281938-1	281934-3	1,5	2,80	4,5	1,57	2,54	*F*	4,19	*O*
281938-2	281934-3	2,5	3,30	4,5	2,21	2,54	*F*	5,08	*O*