

REVISIONS

P	LTR	DESCRIPTION	DATE	DWN	APVD
	BA	NEW RELEASE	20-Sep-08	SM	St.P
	BA1	UPDATE NAME, DIMENSION AND SCHEDULE ADDED	30MAR2023	DM	AP

FOR FURTHER INFORMATION SEE DATA SHEET FOR CFR SERIES-CARBON FILM FIXED RESISTORS

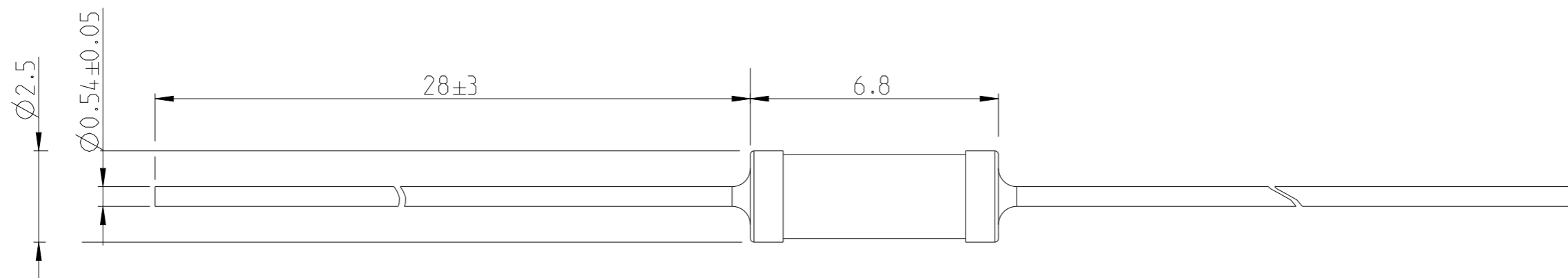

RoHS Compliant

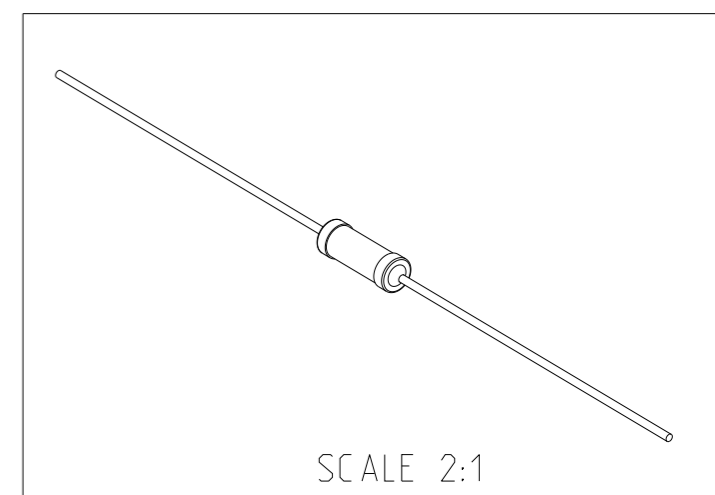

THIS DRAWING IS A CONTROLLED DOCUMENT.		DWN	20SEP2008		 TE Connectivity											
DIMENSIONS: mm		CHK	20SEP2008													
TOLERANCES UNLESS OTHERWISE SPECIFIED:		APVD	20SEP2008													
<table border="1"> <tr><td>0 PLC</td><td>± 0.2</td></tr> <tr><td>1 PLC</td><td>± 0.1</td></tr> <tr><td>2 PLC</td><td>\pm</td></tr> <tr><td>3 PLC</td><td>\pm</td></tr> <tr><td>4 PLC</td><td>\pm</td></tr> <tr><td>ANGLES</td><td>$\pm 5^\circ$</td></tr> </table>		0 PLC	± 0.2	1 PLC		± 0.1	2 PLC	\pm	3 PLC	\pm	4 PLC	\pm	ANGLES	$\pm 5^\circ$	NAME	STEPHEN.P
0 PLC	± 0.2															
1 PLC	± 0.1															
2 PLC	\pm															
3 PLC	\pm															
4 PLC	\pm															
ANGLES	$\pm 5^\circ$															
MATERIAL		PRODUCT SPEC	-		NAME	CARBON FILM FIXED RESISTORS TYPE CFR SERIES										
FINISH		APPLICATION SPEC	-		SIZE	CAGE CODE	DRAWING NO	RESTRICTED TO								
-		WEIGHT	-		A3	00779	C=1623931	-								
-		CUSTOMER DRAWING	-		SCALE	SHEET	REV									
					7:1	1 OF 3	BA1									

REVISIONS

P	LTR	DESCRIPTION	DATE	DWN	APVD
	-	SEE SHEET 1	-	-	-

SCHEDULE			
TCPN	CATALOGUE NUMBER	PART DESCRIPTION	PART STATUS
1623931-1	CFR25J300K	CFR25 5% 300K	DISCONTINUED
1623931-2	CFR25J300R	CFR25 5% 300R	DISCONTINUED
1623931-3	CFR25J30K	CFR25 5% 30K	DISCONTINUED
1623931-4	CFR25J30R	CFR25 5% 30R	DISCONTINUED
1623931-5	CFR25J330K	CFR25 5% 330K	PRODUCTION
1623931-6	1623931-6	CFR25 5% 330K	SUPERSEDED
1623931-7	CFR25J330R	CFR25 5% 330R	PRODUCTION
1623931-8	CFR25J33K	CFR25 5% 33K	PRODUCTION
1623931-9	CFR25J33R	CFR25 5% 33R	PRODUCTION
1-1623931-0	CFR25J360K	CFR25 5% 360K	DISCONTINUED
1-1623931-1	CFR25J360R	CFR25 5% 360R	DISCONTINUED
1-1623931-2	1-1623931-2	CFR25 5% 360R	DISCONTINUED
1-1623931-3	CFR25J36K	CFR25 5% 36K	DISCONTINUED
1-1623931-4	CFR25J36R	CFR25 5% 36R	PRODUCTION
1-1623931-5	CFR25J390K	CFR25 5% 390K	PRODUCTION
1-1623931-6	CFR25J390R	CFR25 5% 390R	PRODUCTION
1-1623931-7	1-1623931-7	CFR25 5% 390R	SUPERSEDED
1-1623931-8	CFR25J39K	CFR25 5% 39K	PRODUCTION
1-1623931-9	CFR25J39R	CFR25 5% 39R	PRODUCTION
2-1623931-0	CFR25J3K0	CFR25 5% 3K0	DISCONTINUED
2-1623931-1	CFR25J3K3	CFR25 5% 3K3	PRODUCTION
2-1623931-2	CFR25J3K6	CFR25 5% 3K6	DISCONTINUED
2-1623931-3	CFR25J3K9	CFR25 5% 3K9	PRODUCTION
2-1623931-4	CFR25J3M3	CFR25 5% 3M3	PRODUCTION
2-1623931-5	CFR25J3M9	CFR25 5% 3M9	PRODUCTION
2-1623931-6	CFR25J3R0	CFR25 5% 3R0	DISCONTINUED
2-1623931-7	CFR25J3R3	CFR25 5% 3R3	PRODUCTION
2-1623931-8	CFR25J3R3	CFR25 5% 3R3	DISCONTINUED
2-1623931-9	CFR25J3R9	CFR25 5% 3R9	PRODUCTION
3-1623931-0	CFR25J430K	CFR25 5% 430K	DISCONTINUED

SCHEDULE			
TCPN	CATALOGUE NUMBER	PART DESCRIPTION	PART STATUS
3-1623931-1	CFR25J430R	CFR25 5% 430R	DISCONTINUED
3-1623931-2	CFR25J43R	CFR25 5% 43R	DISCONTINUED
3-1623931-3	CFR25J470K	CFR25 5% 470K	PRODUCTION
3-1623931-4	CFR25J470R	CFR25 5% 470R	PRODUCTION
3-1623931-5	CFR25J47K	CFR25 5% 47K	PRODUCTION
3-1623931-6	3-1623931-6	CFR25 5% 47K	SUPERSEDED
3-1623931-7	CFR25J47R	CFR25 5% 47R	PRODUCTION
3-1623931-8	CFR25J4K7	CFR25 5% 4K7	PRODUCTION
3-1623931-9	CFR25J4M7	CFR25 5% 4M7	SUPERSEDED
4-1623931-0	CFR25J4M7	CFR25 5% 4M7	PRODUCTION
4-1623931-1	CFR25J4R7	CFR25 5% 4R7	PRODUCTION
4-1623931-2	CFR25J510K	CFR25 5% 510K	DISCONTINUED
4-1623931-3	CFR25J510R	CFR25 5% 510R	DISCONTINUED
4-1623931-4	CFR25J51K	CFR25 5% 51K	PRODUCTION
4-1623931-5	CFR25J51R	CFR25 5% 51R	DISCONTINUED
4-1623931-6	CFR25J560K	CFR25 5% 560K	PRODUCTION
4-1623931-7	CFR25J560R	CFR25 5% 560R	PRODUCTION
4-1623931-8	CFR25J56K	CFR25 5% 56K	PRODUCTION
4-1623931-9	CFR25J56R	CFR25 5% 56R	PRODUCTION
5-1623931-0	5-1623931-0	CFR25 5% 56R	SUPERSEDED
5-1623931-1	CFR25J5K1	CFR25 5% 5K1	DISCONTINUED
5-1623931-2	5-1623931-2	CFR25 5% 5K1	DISCONTINUED
5-1623931-3	CFR25J5K6	CFR25 5% 5K6	PRODUCTION
5-1623931-4	CFR25J5M6	CFR25 5% 5M6	PRODUCTION
5-1623931-5	CFR25J5R1	CFR25 5% 5R1	DISCONTINUED
5-1623931-6	CFR25J5R6	CFR25 5% 5R6	PRODUCTION
5-1623931-7	CFR25J620K	CFR25 5% 620K	DISCONTINUED
5-1623931-8	CFR25J620R	CFR25 5% 620R	DISCONTINUED
5-1623931-9	CFR25J62K	CFR25 5% 62K	DISCONTINUED
6-1623931-0	CFR25J62R	CFR25 5% 62R	DISCONTINUED

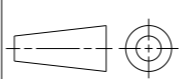
THIS DRAWING IS A CONTROLLED DOCUMENT.		DWN SUBHASH.M 20SEP2008	 TE Connectivity NAME CARBON FILM FIXED RESISTORS TYPE CFR SERIES	
DIMENSIONS: mm		CHK PRAKASH.S 20SEP2008		
		APVD STEPHEN.P 20SEP2008		
TOLERANCES UNLESS OTHERWISE SPECIFIED:		PRODUCT SPEC	SIZE	
0 PLC	±0.2	-	CAGE CODE	
1 PLC	±0.1	-	DRAWING NO	
2 PLC	±	-	RESTRICTED TO	
3 PLC	±	-	SCALE	
4 PLC	±	-	SHEET	
ANGLES	±5°	-	OF	
MATERIAL	FINISH	WEIGHT	REV	
-	-	-	BA1	
-	-	-	CUSTOMER DRAWING	

REVISIONS

P	LTR	DESCRIPTION	DATE	DWN	APVD
	-	SEE SHEET 1	-	-	-

SCHEDULE

TCPN	CATALOGUE NUMBER	PART DESCRIPTION	PART STATUS
6-1623931-1	CFR25J680K	CFR25 5% 680K	PRODUCTION
6-1623931-2	CFR25J680R	CFR25 5% 680R	PRODUCTION
6-1623931-3	CFR25J68K	CFR25 5% 68K	PRODUCTION
6-1623931-4	CFR25J68R	CFR25 5% 68R	PRODUCTION
6-1623931-5	CFR25J6K2	CFR25 5% 6K2	DISCONTINUED
6-1623931-6	CFR25J6K8	CFR25 5% 6K8	PRODUCTION
6-1623931-7	CFR25J6M8	CFR25 5% 6M8	PRODUCTION
6-1623931-8	CFR25J6R8	CFR25 5% 6R8	PRODUCTION
6-1623931-9	CFR25J6R8	CFR25 5% 6R8	DISCONTINUED
7-1623931-0	CFR25J750K	CFR25 5% 750K	PRODUCTION
7-1623931-1	CFR25J750R	CFR25 5% 750R	DISCONTINUED
7-1623931-2	CFR25J75K	CFR25 5% 75K	DISCONTINUED
7-1623931-3	7-1623931-3	USE 7-1623931-4	SUPERSEDED
7-1623931-4	CFR25J75R	CFR25 5% 75R	PRODUCTION
7-1623931-5	CFR25J7K5	CFR25 5% 7K5	DISCONTINUED
7-1623931-6	CFR25J820K	CFR25 5% 820K	PRODUCTION
7-1623931-7	CFR25J820R	CFR25 5% 820R	PRODUCTION
7-1623931-8	CFR25J82K	CFR25 5% 82K	PRODUCTION
7-1623931-9	CFR25J82R	CFR25 5% 82R	PRODUCTION
8-1623931-0	CFR25J82R	CFR25 5% 82R	SUPERSEDED
8-1623931-1	CFR25J8K2	CFR25 5% 8K2	PRODUCTION
8-1623931-2	CFR25J8M2	CFR25 5% 8M2	DISCONTINUED
8-1623931-3	CFR25J8M2	CFR25 5% 8M2	PRODUCTION
8-1623931-4	CFR25J8R2	CFR25 5% 8R2	PRODUCTION
8-1623931-5	CFR25J910K	CFR25 5% 910K	DISCONTINUED
8-1623931-6	CFR25J910R	CFR25 5% 910R	DISCONTINUED
8-1623931-7	CFR25J91K	CFR25 5% 91K	DISCONTINUED
8-1623931-8	CFR25J4K3	CFR25 5% 4K3	DISCONTINUED
8-1623931-9	CFR25J9K1	CFR25 5% 9K1	PRODUCTION
9-1623931-0	CFR25J380K	CFR25 5% 380K	DISCONTINUED
9-1623931-1	CFR25J110K	CFR25 5% 110K	PRODUCTION

THIS DRAWING IS A CONTROLLED DOCUMENT.

DIMENSIONS: mm		TOLERANCES UNLESS OTHERWISE SPECIFIED:	
		0 PLC ±0.2	
		1 PLC ±0.1	
		2 PLC ±-	
		3 PLC ±-	
		4 PLC ±-	
		ANGLES ±5°	
MATERIAL		FINISH	
-		-	
-		-	

DWN	SUBHASH.M	20SEP2008
CHK	PRAKASH.S	20SEP2008
APVD	STEPHEN.P	20SEP2008
PRODUCT SPEC	-	
APPLICATION SPEC	-	
WEIGHT	-	
CUSTOMER DRAWING		



TE Connectivity

NAME
CARBON FILM FIXED RESISTORS
TYPE CFR SERIES

SIZE	CAGE CODE	DRAWING NO	RESTRICTED TO
A3	00779	©-1623931	-

SCALE 5:1 SHEET 3 OF 3 REV BA1